

SEADA

Showing the World



About Us

SEADA Technology Ltd is a UK based 2019 Queen's award for Enterprise winning, world leading manufacturer of Video Wall Controllers, Conference technology and Pro AV solutions. SEADA is also ISO 9001:2015 Quality Management certified.

SEADA's mission is to offer the most innovative and cost-effective solutions for our customers, in video wall controller and conference applications. We work closely with our key partners including distributors and system integrators, SEADA has systems installed worldwide making us a company with a global range.

SEADA has a diverse product range of video wall controllers as well as a conference range for different applications. These include digital signage, command and control, security, education and many more. SEADA's Total Solution allows our customers to purchase everything that they need for their projects from one source. Apart from complex video wall controllers SEADA offer screens, splitters, extenders and even cables. As a result, our products cater for a wide range of applications.

SEADA is proud to be located in the West Midlands, England, birthplace of British Engineering. All our products are manufactured and tested at our UK facility. SEADA will always be available to offer support, not only do we provide full online training videos, webinars, and more advanced one to one training, but we also provide onsite and offsite demos in our UK and US demo rooms.



Content Page

1. Creative Video Wall Controllers:	
• G4K Pro	1
• G8K	3
• GM9	5
2. Solar Wall Range/Family	
• SolarWall	7
• SolarWall Pro	9
• SWMicro	13
• SWNet	14
3. Edge Blending Controller	
• DS2	15
4. Seamless Matrix Switcher	
• SWMP	17
5. AV over IP	
• Genesis 265	19
• Genesis Lite	20
• G500	21
• G2000	23
6. G Series Video Wall Controllers	
• G44 HDMI	25
• G88	26
• G24	27
7. Presentation Switchers	
• SD-PS-M641	28
• TapPlay™ Wireless	29
8. Multiviewers	
• SD-MV-CM41	31
• SD-MV-CM61	32
• SD-MV-0901	33
• SD-MV-0401P	33
• SD-MV-0501P	34
9. Matrix Switcher	
• MS-HV51B	35
• MS-HBTB66C70	36
• MS-HBT44B70	37
• MS-HBT88B70	37
• MS-HBT44B100	38
• MS-HBT88B100	38
• MS-HDM44	39
• MS-HDM88	40
• MS-HDM41BA	41
10. Conference Solutions	
10.1 Retractable & Foldable Monitors	
• SC13W	42
• SC13FM	42
• Mseries	43
• GSeries	44
• SC13FP	44
• SC17FZD	45
• SC 15FZW	45
• SC 17FZW	45

10.2 Connectivity Boxes	
• SC-DA	46
• SC-DB	46
• SC-DC	46
• SC-11D	46
10.3 Cameras	
• PTZ Camera	47
• AI Tracking PTZ Camera	48
• Control Keyboards	49
• SDC-AV4K	50
11. Wall Plate Panels	
11.1 Control Panels	
• SDCP6	51
• SDCP7	51
• SDCP10	51
11.2 HDBaseT Extenders	
• SD-WP31V	52
• SD-WP31C	52
• SD-WP31D	52
12. Extenders	
12.1 HDBaseT Extenders	
• HBT70S	53
• HBT70B	53
• HBT100B	54
• HBT150B	54
12.2 Fiber Optic Extenders	
• FO-F02P	55
13. USB Extenders	
• SD-USB50	56
• SD-USB100	56
14. Splitters	
• SP-H14B	57
• SP-H18B	57
• SD-0102-4K60	58
• SD-0104-4K60	58
15. KVM	
• KVM50HD HDMI/USB	59
• HBT100UB	60
16. HDMI & SDI Converters	
• SD-HTS	61
• SD-STH	61
17. Video Capture	
• SD-HU	62
• SD-UHU	62
18. Video Wall Screens	
• Video Wall Screen	63
19. Cables	
19.1 4K Premium HDMI	
• SCHM Series	64
19.2 Active Optical	
• SC-4K60 Series Cable	65
• SC-AVC Series	65
• SC-DPH	66
• SC-UMM Series	66
• SC-UFM Series	66



*Training videos available upon request



*Webinar available upon request



G4K Pro

Creative Video Wall Controllers



The G4K Pro stand alone series video wall controller is the perfect solution for eye catching digital signage displays with its ability to support audio and any degree rotation on each output.



Key Features

- 4K HDMI input
- Four HDMI outputs
- Custom preset layouts
- Call up preset layouts via 3rd party controller
- Call up preset layouts via iPhone
- Call up preset layouts via control PC
- HDCP compliant
- Supports audio
- Unlimited daisy chain expansion feature supports gigantic video walls
- Fanless design
- Each Output supports resolutions up to 1080p Full HD and 1920x1200
- Lockable power supply

SPECIFICATIONS

INPUT RESOLUTION	UP TO 3840x2400
INPUT FORMAT	HDMI 4K
OUTPUT RESOLUTION	UP TO 1920x1200
OUTPUT FORMAT	HDMI 1.3
AUDIO SUPPORT	YES
BEZEL CORRECTION	YES
EDGE OVERLAP	YES
CONTROL INTERFACE	10/100/1000M ETHERNET PORT
DAISY CHAIN EXPANSION	YES
OPERATING TEMPERATURE RANGE	0~40° CENTIGRADE
OPERATING HUMIDITY RANGE	10%-90%
STORAGE TEMPERATURE RANGE	0~60° CENTIGRADE
STORAGE HUMIDITY RANGE	10%-90%
DIMENSIONS (IN MM)	208(W) x 44.5(H) x 200 (D)

Any Degree Rotation



DESCRIPTION

The G4K Pro standalone series video wall controllers accept a single 4K input source and divides it across up to four displays, each with a resolution up to 1920x1200 @ 60Hz.

Each output supports rotation of any degrees. Each output is also able to crop the original input content arbitrarily.

The resolution and frame rate of outputs can be upscaled and downscaled freely for all sorts of applications. In addition, whenever the input signal includes embedded audio, the G4K Pro is able to support audio output. This makes the G4K Pro the ideal solution for eye catching creative video walls, where audio is also required.

G4K Pro controllers can be easily configured via IP connection to a Windows based PC running management software. The Windows based software provides a user friendly GUI, greatly simplifying the system configuration. G4K Pro controllers are able to run standalone without the connection to the control PC, once configured.

G4K Pro controllers support all popular outputs, including LCD, DLP and LED displays with its perfect frame lock on all output channels, along with projectors for edge blending applications.

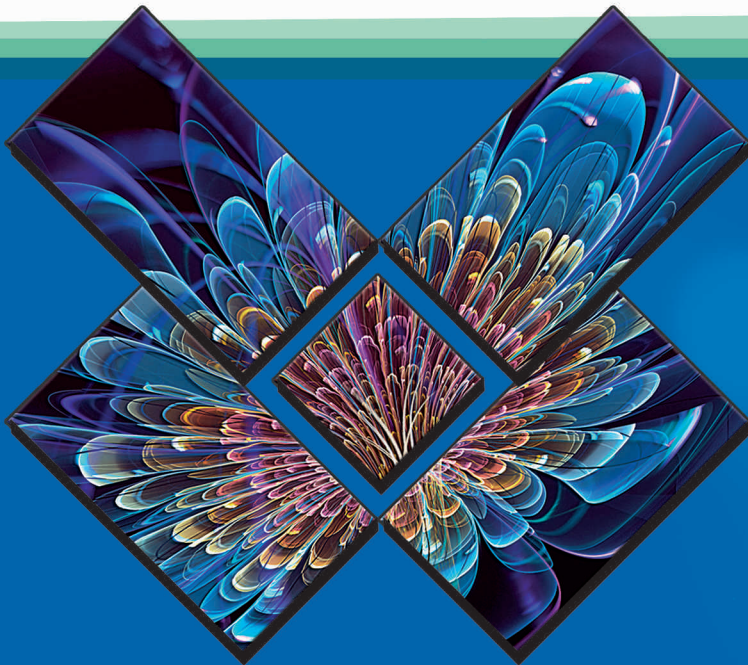

G4K Pro



Supports Audio



MODELS

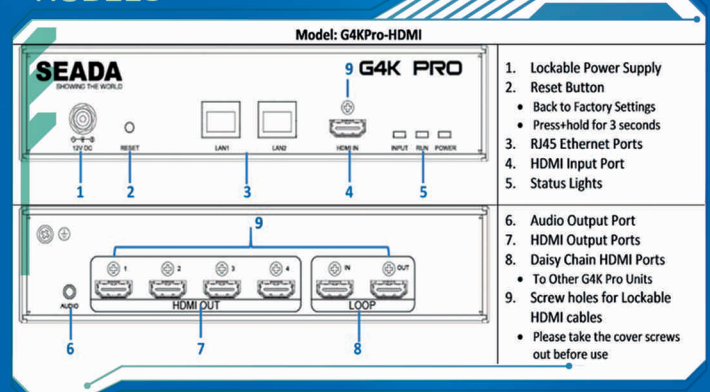

G8K

Creative Video Wall Controllers



Key Features

- Any degree rotation on each output to form eye catching video wall layout
- Built in 8K media player with 128G on board storage
- One 4K@60 HDMI capture channel
- Support picture in picture with HDMI capture source
- Up to 6 HD HDMI or 3 4K HDMI outputs
- Custom pre-set layouts
- Unique cloud features like messenger
- Supports customised scrolling text
- Display photos from local PC/USB/phones onto video wall
- Supports alpha compositing on HDMI capture video input
- Bezel Compensation for all types of displays provides accurate display of the image
- Controllable via IP or RS232
- Supports LED video wall with its perfect frame lock between outputs
- Supports a variety of shaped open windows
- Supports special effects on video windows edge

SPECIFICATIONS

MEDIA PLAYER	8K RESOLUTION
STORAGE	128GB
VIDEO INPUT	HDMI 2.0 x1
INPUT RESOLUTION	UP TO 4K@60
OUTPUT RESOLUTION	UP TO 4K ON 3 HDMI CHANNELS OR 1920X1200 ON 6 CHANNELS
VIDEO OUTPUT	HDMI 1.3 x6 or HDMI 2.0 x3
AUDIO OUTPUT INTERFACE	RCA, OPTICAL
POWER SUPPLY	12DC FROM MAIN POWER ADAPTER (AC 110V TO 250V, 50/60HZ)
BEZEL CORRECTION	YES
USB 3.0 PORT	2
CONTROL INTERFACE	IP/RS232

DESCRIPTION

The G8K standalone series video wall controllers consist of a 128GB onboard 8K Media Player for playing both 8K videos and photos, one 4K@60P HDMI capture channel, scrolling text, two USB ports and one Cloud messenger for sending the photos and greetings onto video wall, which means it can display multi contents onto the video wall with Picture in Picture ability.

G8K supports any degree rotation on each output with the ability to upscale and downscale the resolution freely for all sorts of applications.

This makes the G8K the ideal solution for eye catching creative video walls, where the screens are in an irregular layout.

G8K controllers support all popular outputs, including LCD, DLP and LED displays with its perfect frame lock on all output channels, along with projectors for edge blending applications.

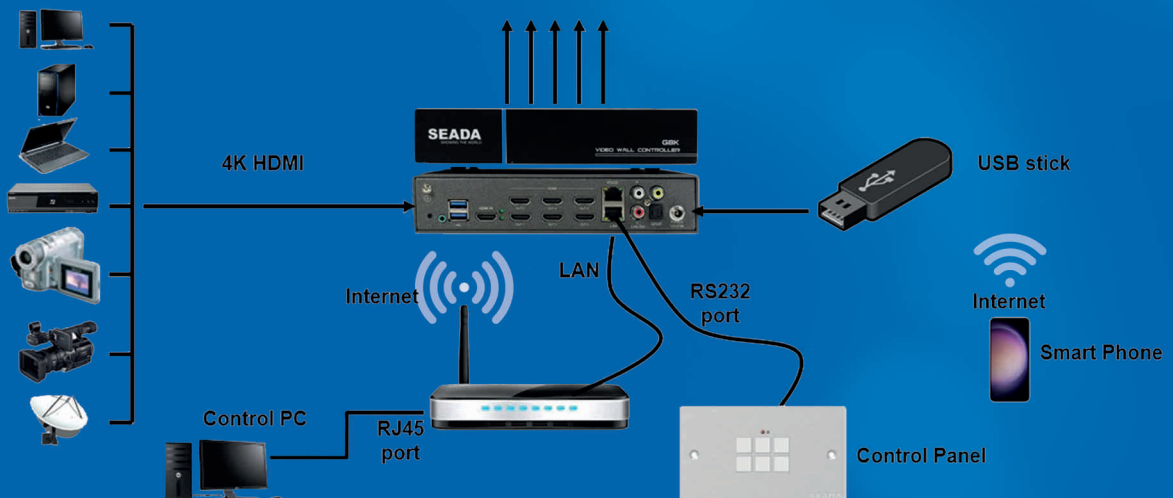

GM9

Creative Video Wall Controllers



Key Features

- 64G built in media player
- One HDMI capture channel
- Up to 9 HDMI outputs
- Supports audio
- Scrolling OSD
- Custom preset layouts
- Cloud features like messenger
- Display photos from local PC, USB or phones
- Bezel Compensation
- Supports a variety of shaped open windows
- Supports LED video wall
- Supports alpha composition on HDMI capture channel
- Controllable via IP or RS232

SPECIFICATIONS

VIDEO INPUT	HDMI 1.3 x 1
INPUT RESOLUTION	UP TO 1920x1200
VIDEO OUTPUT	HDMI 1.3 x 9
OUTPUT RESOLUTION	UP TO 1920x1200
MEDIA PLAYER	4K RESOLUTION
STORAGE	64GB
AUDIO OUTPUT INTERFACE	RCA
POWER SUPPLY	12DC FROM MAIN POWER ADAPTER (AC 110V to 250V, 50/60Hz)
BEZEL CORRECTION	Yes
USB 3.0 PORTS	2
CONTROL INTERFACE	IP/RS232

DESCRIPTION

The GM9 standalone series video wall controllers consist of a 64GB on board 4K Media Player for playing both videos and photos, one HDMI capture channel, scrolling text, two USB ports and one Cloud messenger for sending the photos and greetings onto video wall, which means it can display multi contents onto the video wall with Picture in Picture ability.

GM9 supports any degree rotation on each output with the ability to upscale and downscale the resolution freely for all sorts of applications. This makes the GM9 the ideal solution for eye catching creative video walls, where the screens are in irregular layout.

GM9 controller supports alpha composition on its HDMI capture channel which means users can display the HDMI input content in windows on video wall with customised shapes besides standard rectangle shapes. This feature makes the video wall more fun and interesting.

GM9 controllers support all popular outputs, including LCD, DLP and LED displays with its perfect frame lock on all output channels, along with projectors for edge blending applications.



ANY DEGREE ROTATION

BUILT IN 4K MEDIA PLAYER
SUPPORTS AUDIO



SolarWall

Video Wall Controllers



Key Features

- Advanced CrossBar technology
- Robust FPGA video data process technology
- Multi-window overlay ability
- Mutli input and output formats
- No PC vulnerabilities
- Input signal preview
- 1 to 144 display outputs
- HDCP support for DVI/HDMI
- Four-window overlay mode
- Low power consumption
- IP streaming decode support
- Multi video wall support in one system
- Fast start up within 5 Seconds
- Supports 4K input/output

SW2000



The SW2000 family of video wall controllers provide excellent performance along with support for very large display walls.

Employing high speed FPGA and Crossbar technology, our entry level systems ensure the real-time processing of input signals. SW2000 controllers offer up to 144 graphics outputs and up to 128 HD inputs.

	SW2008	SW2016	SW2036	SW2072A	SW2072B	SW2144
INPUTS	8 HD/32 CVBS	16 HD/64 CVBS	32 HD/128 CVBS	64 HD/256 CVBS	128 HD/512 CVBS	128 HD/512 CVBS
OUTPUTS	8	16	36	72	72	144

SW4000

The SW4000 family of controllers benefit from higher bandwidth than the entry level SW2000 range. Displaying up to four video overlay windows per output screen, the SW4000 range is the perfect solution for applications where the number of video inputs are more than double the number of display screens.

	SW4008	SW4018	SW4036	SW4072
INPUTS	24 HD/96 CVBS	52 HD/208 CVBS	96 HD/384 CVBS	128 HD/512 CVBS
OUTPUTS	8	18	36	72



SW8000

The SW8000 systems are Seada Technology's latest 4K video wall controllers, offering up to 4K resolution on both input and output channels.

	SW8004	SW8008	SW8018	SW8036
INPUTS	24 HD/4 UHD4K	52 HD/8 UHD4K	96 HD/16 UHD4K	128 HD/36 UHD4K
OUTPUTS	4 UHD4K	8 UHD4K	18 UHD4K	36 UHD4K

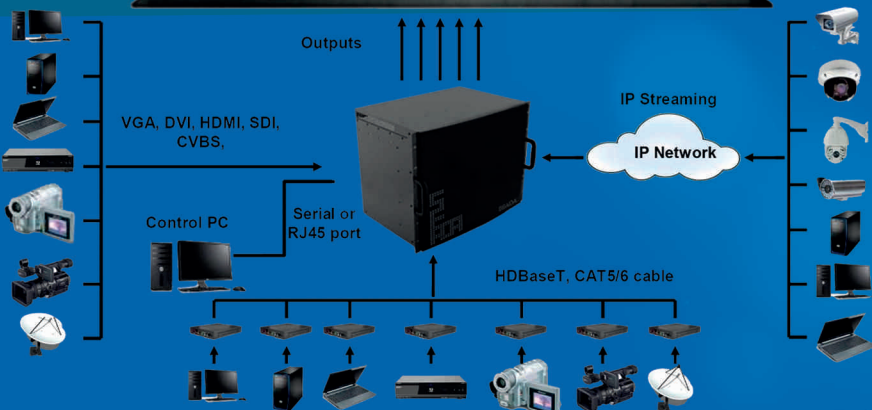

Multi input option:

HDMI, DVI-D, VGA, YPbPr, CVBS, SDI, HDBaseT, Optical Fibre, IP streaming

Multi output option:

HDMI, DVI-I (Digital & Analog), SDI, HDBaseT, Optical Fibre

SolarWall Pro

Video Wall Controllers

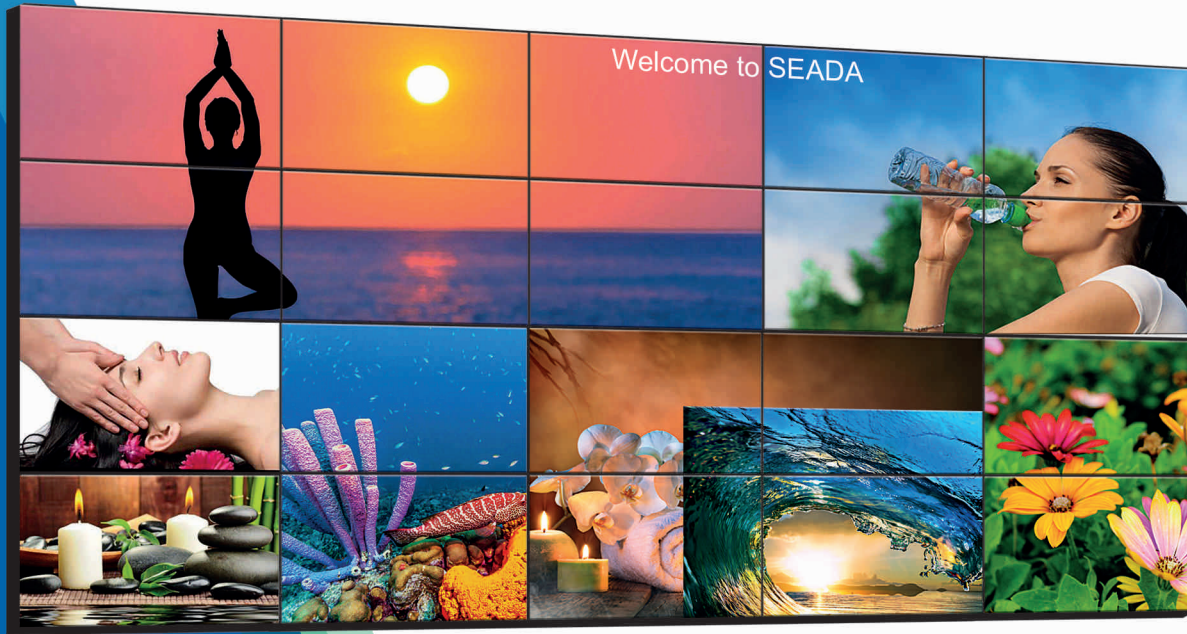

Key Features

- Advanced PCI Express technology
- Advanced Crossbar technology
- Supports 4K@60fps input and output*
- Supports digital and analog audio*
- Supports KVM*
- Supports scrolling text*
- Supports input signal preview
- Supports local video wall mapping
- Supports system live monitoring
- Supports OSD on output windows*
- Supports 4K IP streaming decoding*
- Multi clients support*
- User access control
- Robust FPGA video data process technology
- No PC vulnerabilities
- Multi output option: DVI-I (Digital & Analog), HDMI, HDBaset, Optical Fibre
- Low power consumption
- Multi video walls support in one system
- Multi input option: DVI-D, HDMI, VGA, SD, SDI, HDBaset, Optical Fibre
- HDCP compliant
- Supports customised EDID on inputs and outputs
- Supports over 1000 pre-set layouts*
- Layouts looping ability

* Features exclusive to SolarWall Pro

SPECIFICATIONS

INPUT CHANNEL	UP TO 320 INPUTS
INPUT FORMAT	DVI/HDMI/VGA/SDI/SD/IP/HDBASET/DP/FIBRE
OUTPUT CHANNEL	UP TO 320 OUTPUTS
OUTPUT FORMAT	DVI/HDMI/VGA/HDBASET/FIBRE
HDCP SUPPORT	YES
POWER SUPPLY	SINGLE OR RPSU
INPUT VOLTAGE	AC 110V-240V, 50/60 HZ
CONTROL INTERFACE	RS232/10/100/1000M ETHERNET PORT



DESCRIPTION

SolarWall Pro series controllers apply PCI express technology to provide high bandwidth for real-time processing of all input signals and better system performance.

SolarWall Pro controllers are also able to offer extremely fast start-up performance and a working environment free of viruses and software conflicts, ensuring 24/7 hassle free operational ability.

The SolarWall Pro series video wall controllers are the most advanced solution available from SEADA technology. Based on cutting edge PCI express technology, they provide excellent performance and flexibility for video wall applications, supporting video walls with features of KVM, input preview, on screen scrolling text and so on.

MODELS

MODELS	CHASSIS	DIMENSIONS (MM) (W*D*H)	MAX INPUT (HD)	MAX OUTPUT (HD)
SWP02	2U	482*380*88	16*	8*
SWP04	4U	482*380*175	32*	20*
SWP10	10U	482*380*440	76*	40*
SWP16	16U	482*380*708	156*	40*
SWP28	28U	482*380*1240	160	160
SWP30D	30UD	940*450*1350	320	320

*Not simultaneously



System Diagram

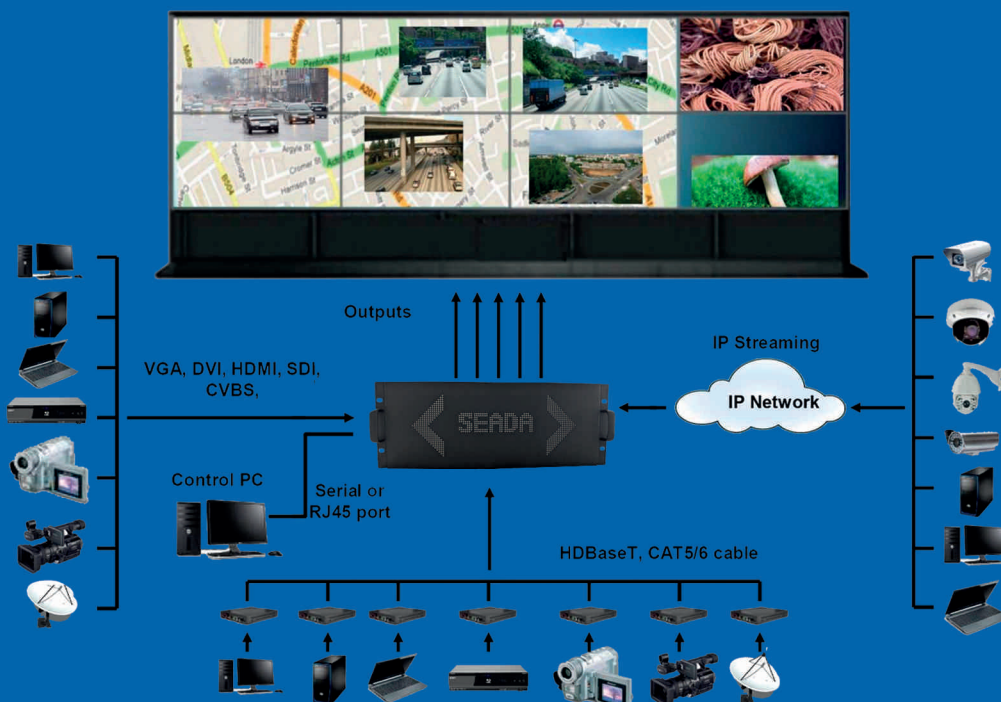

SolarWall Pro

Video Wall Controllers



Unique Features Examples

MIRRORING

This feature is optional and enabled with 'SWPro-MP' card added in the system. The card is a Video wall mapping card with 2 HDMI and 1 IP outputs, supporting mapping up to two video walls per card via HDMI or IP, supporting audio as well. With this feature, some users are able to see the whole video wall content at 1080@60fps quality at a local PC in their offices instead of in the command-and-control room.



SWPro

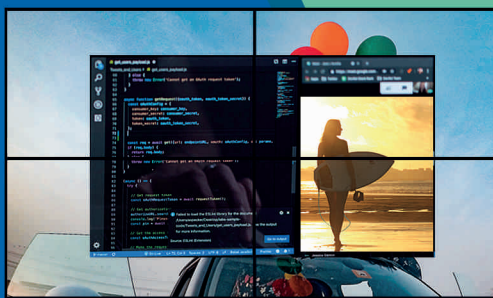

SWPro



KVM

The SolarWall Pro supports KVM. With the addition of the "SWPro-DC" card, users can choose if they want KVM support for their SWPro. Simply connect your laptop or computer with a standard USB Type B to USB type A cable and map the connection on your software. As easy as that you will be able to use the KVM feature!

Differences between SWPro and SolarWall

FEATURES	SWPro	SW4000 example
OSD	On Input, Output and Video Wall	Only on Input
Scrolling text	✓	✗
Inputs supported on one screen	Up to 8 including background picture	Up to 4 without the background picture
Preview	✓	Optional
Looping	Does not require connection to PC	Requires connection to PC
KVM	✓	✗
Preset Hotkey	✓	✗
Template Layouts	✓	✗
Offline Preset	✓	✗
Video Wall Support	Unlimited	Up to 4
Layouts	1000	128
Video Wall Mirroring	✓	✗
Wall Mouse	✓	✗
Layout & Loop Organization	✓	✗
Supports Audio	✓	✗
Background Picture	.jpg and .bmp	.bmp
IP streaming	4K IP Streaming (H265)	HD Only (H264)
Multiple Control Clients Support	✓	✗

SWPro

SolarWall

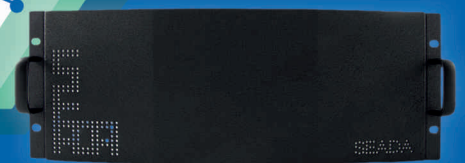

Free Training

BASIC SETTINGS

EXTRAS

INSTALLING CARDS

IP STREAMING

solarWall Pro

KVM AND MIRRORING

LAYOUTS AND LOOP

TOOLBAR AND OSD



UNLIMITED VIDEO WALL

SWMicro Video Wall Controller

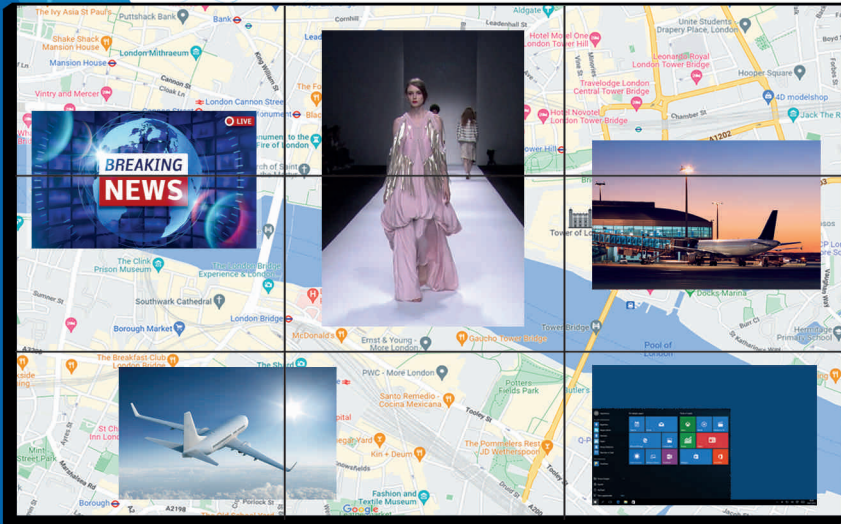

DESCRIPTION

SWMicro series controllers apply crossbar technology to provide high bandwidth for real-time processing of all input signals and better system performance. The layout of the windows can be configured separately by the universal SWMicro management software, which offers flexibility within an intuitive interface, they provide excellent performance and flexibility for video wall applications.

SWMicro controllers are also able to offer extremely fast start-up performance and a working environment free of viruses and software conflicts, ensuring 24/7 hassle free operational ability.

SWMicro supports 8 HDMI inputs, and SWMicroP supports 4 HDMI with 1 4K HDMI/DP inputs.



Key Features

- Advanced Crossbar technology
- 8 HDMI inputs or 4 HDMI with 1 4K HDMI /DP
- Up to 16 HDMI outputs
- Multi clients' support
- User access control
- Robust FPGA video data process technology
- No PC vulnerabilities
- Two or four-window overlay mode*
- Low power consumption
- Multi video walls support in one system
- HDCP compliant
- Supports custom pre-set layouts
- Layouts looping ability
- Picture-in-Picture display of two or four live, moving video input signals over any output screen*
- Input capture freeze
- Offline presets

* Output ports amount is halved when working on Four-window overlay mode

SPECIFICATIONS

CONTROLLER CHASIS	19" ANST/EIA RS-310C STANDARD INDUSTRIAL CHASSIS
INPUT CHANNEL	UP TO 8 INPUTS or 4 HD HDMI INPUTS WITH 1 4K HDMI/ DP INPUT
INPUT FORMAT	HDMI
OUTPUT CHANNEL	UP TO 16 OUTPUTS
OUTPUT FORMAT	HDMI
HDCP SUPPORT	YES
POWER SUPPLY	SINGLE
INPUT VOLTAGE	AC 100V TO 240V, 50/60HZ
OPERATION SYSTEM	WINDOWS 7/8/9/10/11
CONTROL INTERFACE	RS232 OR 10/100/100M ETHERNET PORT

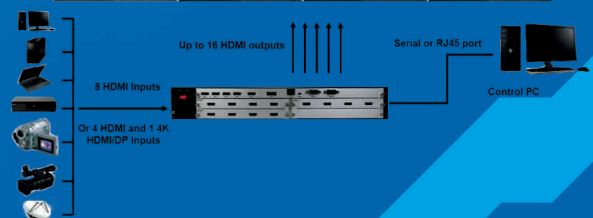

SWNet IoT Management System

DESCRIPTION

The SolarWall Net (SWNet) IoT Management System is an innovative management platform for configuring and operating multiple video walls, KVM matrix, RTSP IP streaming, encoders/decoders, and controlling 3rd party devices. SWNet simplifies the deployment of complex AV-over-IP projects, without the need for any expensive server to run it on.

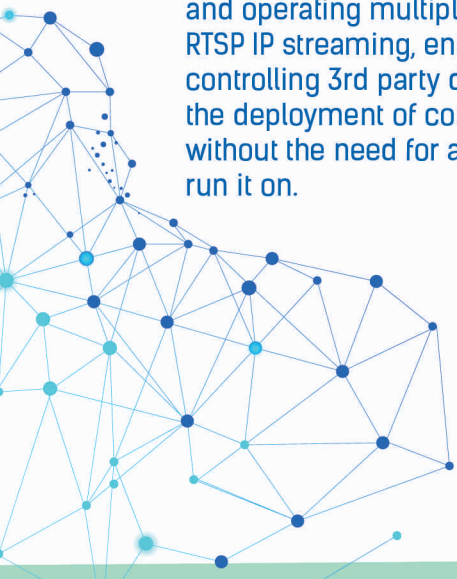
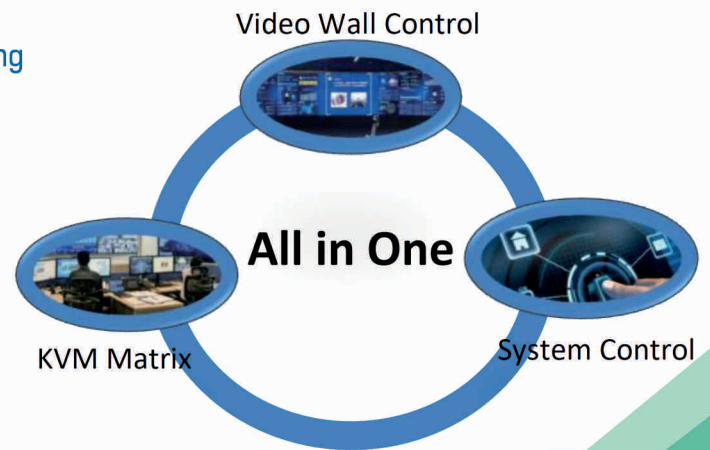

Key Features



- A universal solution with simple installation and administration
- Supports unlimited number of endpoints
- Compatible with 3rd party RTSP streaming and preview
- Supports controlling 3rd party devices
- Supports multi video walls
- Supports multi-level users
- Supports move & switch between monitors on KVM
- Supports sources preview on KVM, video wall
- Supports drag & drop on KVM and video wall
- Supports push & pull between KVM stations
- Supports push & pull between KVM and video wall
- Supports OSD
- Supports scrolling text on video wall
- Supports customised pre-set layouts

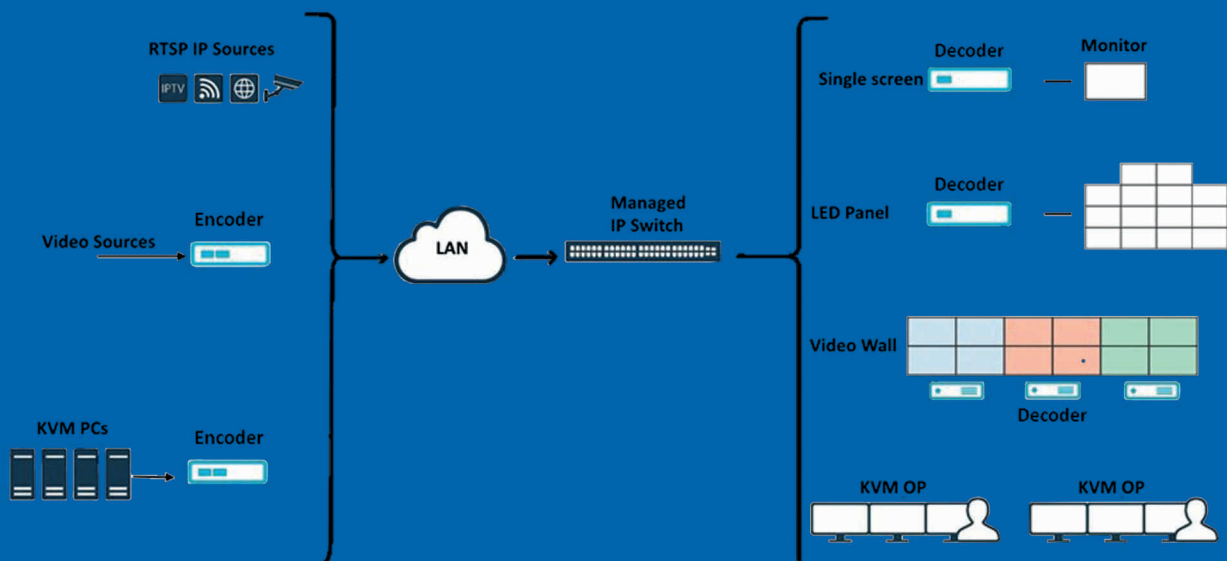

DS 2

Edge Blending Controller



DS 2 – 3H



DS 2 – 9H

Key Features

- Built in 4K media player
- One HDMI capture channel
- Up to 9 HDMI outputs
- Custom pre-set layouts
- HDCP compliant
- Independent colour adjustment for each connected projector
- Advanced overlapped area colour correction
- Supports flat, curved or spherical projection surfaces
- Each Output supports resolutions up to 1080p Full HD and 1920x1200
- Video wall controller function with PiP, zoom, position and so on features
- Bezel Compensation for all types of displays provides accurate display of the image
- Supports any degree rotation on each individual output, to enable creation of irregular video walls
- Controllable via IP or RS232
- Supports a variety of shaped open windows, such as heart-shaped, diamond, square, clouds and so on
- Supports special effects on up to 4 video windows edge



DESCRIPTION

The DS 2 is the device combining an edge blender, video wall controller and 4K media player together in one unit. It is not only able to blend up to 9 projectors together into one flat seamless display but also able to warp geometries on non-standard surfaces to form curved or spherical projection surface.

In addition to its ability of edge blending at the output sides, DS 2 is able to capture one HDMI video source and display it onto the projection screen anywhere and any size. Moreover, DS 2 also has an embedded 4K media player which enables DS 2 to output 4K video source played locally in addition to the captured HDMI video source.

DS 2 units can be easily configured via IP connection or RS232 to a Windows based PC running management software. The Windows based software provides a user-friendly GUI, greatly simplifying the system configuration. DS 2 units are able to run standalone without the connection to the control PC, once configured.

DS 2 unit can work with LCD, DLP and LED displays as well to form a stand or creative video wall with its ability to rotate the output at any degree.

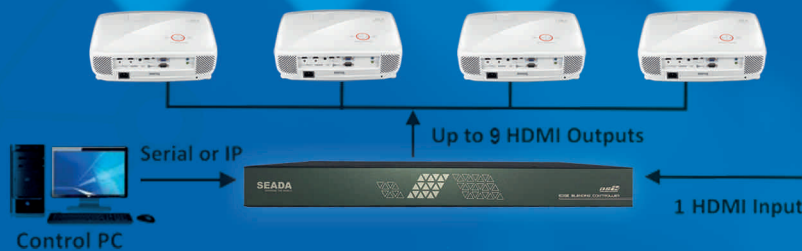

SPECIFICATIONS

INPUT CONNECTOR	HDMI TYPE A
OUTPUT RESOLUTION	UP TO 1920 x 1200
OUTPUT FORMAT	HDMI TYPE A
EMBEDDED 4K MEDIA PLAYER	YES
POWER SUPPLY	12V, 3A DC FROM MAIN POWER ADAPTERS
BEZEL CORRECTION	YES
EDGE BLENDING	YES
GEOMETRY CORRECTION	YES
GAMMA CORRECTION	YES
CONTROL INTERFACE	RS232 OR 10/100/1000M ETHERNET PORT

MODELS

MODELS	MAX INPUT (HD)	MAX OUTPUT (HD)
DS2-3H	1x HDMI	3x HDMI
DS2-9H	1x HDMI	9x HDMI

SWMP

Seamless Modular Matrix Switcher

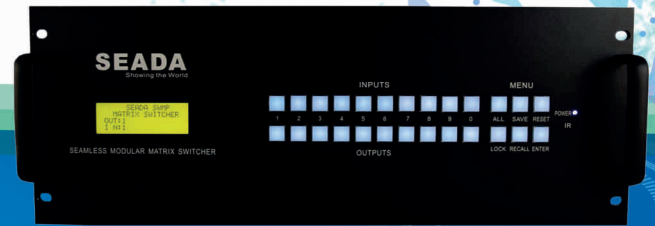

Key Features

- Advanced Crossbar technology
- Seamless switching
- Supports 4K@60fps (4:4:4) input and output
- Supports audio
- Supports OSD on output windows
- Supports individual screen customised video setting
- No PC vulnerabilities
- Multi output option
- Low power consumption
- Supports video wall feature
- Multi input option
- HDCP compliant
- Supports customised EDID on inputs and outputs
- Supports customised preset layout
- Redundant power supply
- Support up/down scaling
- HDBaseT with PoC

SPECIFICATIONS

CONTROLLER CHASSIS	19" ANST/EIA RS-310C STANDARD INDUSTRIAL CHASSIS
INPUT CHANNEL	UP TO 80 INPUTS
INPUT FORMAT	DVI/HDMI/VGA, SDI, SD, HDBASET, FIBRE
OUTPUT CHANNEL	UP TO 80 OUTPUTS
OUTPUT FORMAT	DVI/HDMI/VGA, SDI, SD, HDBASET, FIBRE
HDCP SUPPORT	YES
POWER SUPPLY	RPSU
INPUT VOLTAGE	AC 110V TO 240V, 50/60HZ
OPERATION SYSTEM	WINDOWS 7/8/10
CONTROL INTERFACE	RS232 OR 10/100/1000M ETHERNET PORT

DESCRIPTION

The SWMP Modular seamless series matrix switchers offer advanced access and real-time control of multiple local and remote A/V input devices and displays from a single chassis at 4K 60Hz 4:4:4 resolution.

The SWMP switcher allows users to independently switch and route video and audio content directly to various monitors, displays, projectors and/or 'speakers simply by using front panel pushbuttons, remote control or controlling via TCP/IP or RS232. A built-in Scaler encodes the video format to provide seamless real-time switching.

The SWMP matrix switchers are also able to offer extremely fast start-up performance and a working environment free of viruses and software conflicts, ensuring 24/7 hassle free operational ability.

MODELS

MODELS	CHASSIS	DIMENSIONS (MM) (W*D*H)	MAX INPUT (HD)	MAX OUTPUT (HD)
SWMP08	2U	482*380*88	8	8
SWMP16	4U	482*380*175	16	16
SWMP36	8U	482*380*353	36	36
SWMP80	16U	482*380*708	80	80

Multi input option:
DVI, HDMI, VGA, SDI,
HDBaseT

Multi output option:
DVI, HDMI, HDBaseT,
SDI, VGA

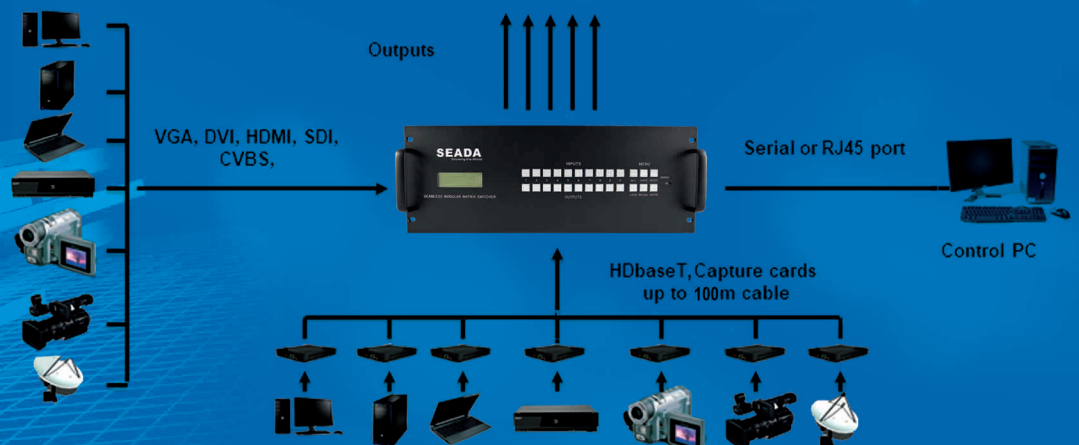

Genesis 265

AV over IP

Video Wall Controller



DESCRIPTION

The GENESIS™265 encoders and decoders are designed to transmit video and audio over standard Gigabit Ethernet with low latency and high image quality in real-time.

With its unique video wall controller ability built in, The GENESIS™265 can be used as multi-viewers or matrix switchers for applications in command & control centre, conference room, corporation, university and so on.

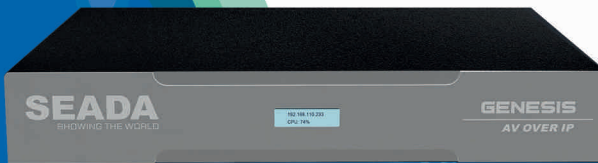

Key Features

- Fanless design, no moving parts
- Supports H.265/264 for high quality AV-over-IP
- Supports multi-view and matrix switching
- Supports inputs any size, anywhere on screen
- Supports PoE
- Supports both digital and analog audio
- Supports RS232, RS485, IR, Relay and I/O
- Supports up to 3840 x 2160
- Supports up to 16 inputs per screen as decoder
- Supports up scaling and down scaling
- Supports input content cropping
- Supports drag and drop
- Supports scrolling text and OSD
- Supports marking on source
- Supports custom desktop background image
- Supports input signal real-time preview
- Supports 3rd party RTSP decoders
- Supports 3rd party RTSP sources (e.g., IP camera) decoding/displaying
- Supports Multicast
- Supports preset layouts
- Low latency

SPECIFICATIONS

INPUT/OUTPUT	RTSP HDMI+Fibre
OUTPUT FORMAT PROTOCOL	H265/H264
RS232 CONNECTION	PHOENIX CONNECTOR
POWER SUPPLY	12V FROM MAIN POWER ADAPTER OR PoE
AUDIO INPUT/OUTPUT CONNECTOR	PHOENIX CONNECTOR
AUDIO INPUT/OUTPUT	UNBALANCED

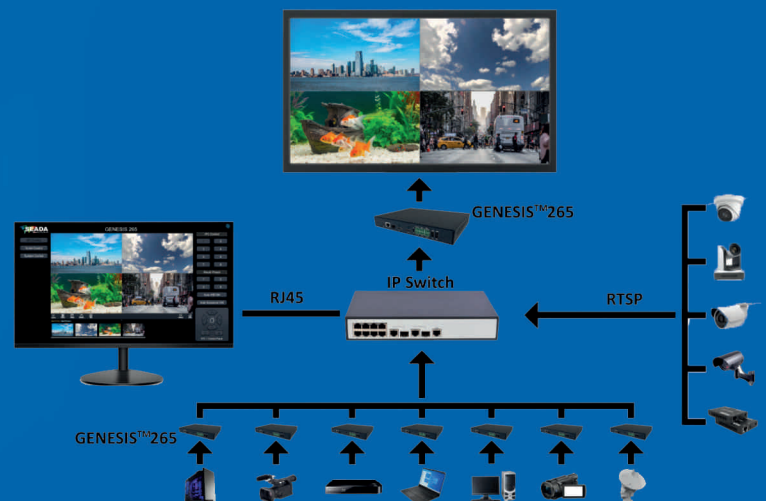

Genesis Lite

HDMI over IP Extender with Loop out (100M)

DESCRIPTION

The GLite HDMI over IP Extender is based on AV over IP solution for distribution of one HD content to one HD display device or to multiple HD display devices over a standard IG network switcher, and extends distance up to 100m/328ft between encoder and decoder via Cat5e/6 cable. It offers configurable high quality, low-bandwidth H.265 compression video. The resolution up to 1920×1200@ 60Hz YCbCr 4:4:4. It also supports HDMI loop output.

HDMI over IP Extender includes two units: encoder and decoder. The encoder is used to capture the HDMI input with IR blaster signal and carries the signals via one effective Cat5e/6 cable, and the encoder can also support HDMI loop output.



Key Features

- HDMI 1.4b, HDCP 1.4 compliant
- Supports 10.2Gbps bandwidth
- Video resolution up to 1920×1200@60Hz YCbCr 4:4:4
- Extend distance up to 100m/328ft betw Encoder and Decoder via Cat5e/6 cable supports standard H.265 and H.264 encoding / decoding
- Supports IG standard IP switcher / router / hub
- Supports one-way IR control
- Compact design for easy and flexible installation

SPECIFICATIONS

TECHNICAL	
COMPLIANCE	HDMI1.4B, HDCP1.4
VIDEO BANDWIDTH	10.2 GBPS
VIDEO RESOLUTION	640x480@60HZ-1920x1200 @60HZ
HDMI AUDIO FORMATS	LPCM
COMPRESSION TECHNOLOGY	H.265/H.264
REQUEST FOR SWITCH/ROUTER	SUPPORT IGMP, SUPPORT HDCP
COLOUR SPACE	RGB, YCBCR 4:4:4, YCBCR 4:2:2
COLOUR DEPTH	8-BIT
CONNECTIONS	
ENCODER	INPUTS:1x HDMI TYPE A OUTPUTS: 1x HDMI TYPE A 1x IR OUT 1x CAT OUT
DECODER	INPUTS: 1x IR IN 1x CAT OUT IN OUTPUTS: 1x HDMI TYPE A
MECHANICAL	
DIMENSIONS (IN MM)	88(W) x 61.2 (D) x 16.5 (H)
WEIGHT	155G
POWER SUPPLY	DC 5V/1A
POWER CONSUMPTION	ENCODER: 1.5W, DECODER: 1.25W

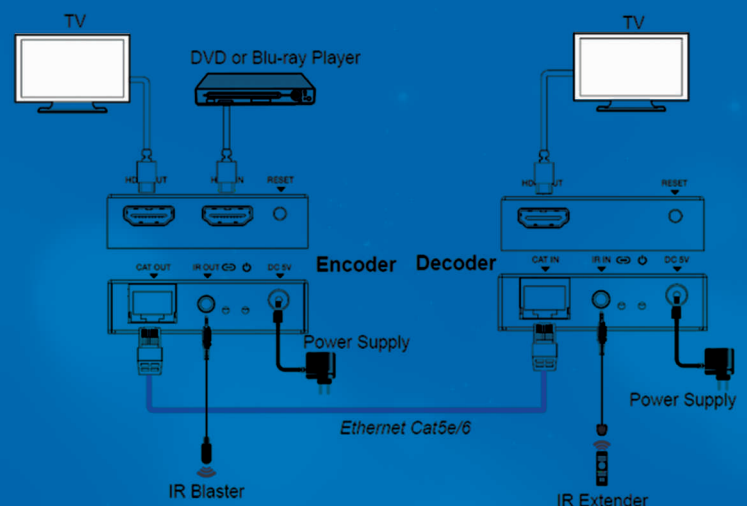

G500

Genesis Streaming



G501DH



G502ES



G502EH

DESCRIPTION

G501EH/G501ES are the new Genesis AV-over-IP streaming encoders. They can encode 1 HDMI input for up to 1080P using H264/H65 video codecs. Both units support multiple streaming protocols such as RTMP and RTSP, giving user the chance of easy streaming on live platforms like YouTube or decoding using any 3rd party device that supports the corresponding protocol.

G501DH is the Genesis AV-over-IP streaming decoder. It can decode up to 4 live streams and output them in up to 2x2 multiview with a resolution up to 4k

Key Features

- Supports encoding or decoding depending on the model.
- Flexible option of models for HDMI and SDI input.
- Supports multiple streaming protocols, including RTMP, HTTP, HLS, SRT, RTP, ONVIF, UDP Unicast/Multicast and RTSP over UDP/TCP.
- Supports encoding 1 HDMI or SDI input in two stream channels with a resolution up to 1080P.
- Supports codec configuration for parameters such as resolution, bitrate and key interval.
- Supports decoding up to 4 streams and output via HDMI or SDI at a single screen, 1x2 or 2x2 multiview.
- Supports selectable audio input or output between 3.5mm mini jack and embedded HDMI.
- RS485 port for PTZ camera control.
- User-friendly WebUI for configuration.

SPECIFICATIONS

MODEL NAME	G501EH	G501ES	G501DH
INPUT	INPUT: HDMI x1	INPUT: SDI x1	-
INPUT RESOLUTION	1080P@60	1080P@60	-
OUTPUT	-	-	1x HDMI, 1x SDI
ENCODING FORMAT	H264/H265	H264/H265	3840X2160
ENCODING BITRATE	16-20000	16-20000	-
SIMULTANEOUS STREAMING	UP TO 2	UP TO 2	-
SIMULTANEOUS DECODING	-	-	4
PROTOCOL	RTMP, HTTP, HLS, SRT, RTP, ONVIF, UDP, UNICAST/MULTICAST AND RTSP OVER UDP/TCP	RTMP, HTTP, HLS, SRT, RTP, ONVIF, UDP, UNICAST/MULTICAST AND RTSP OVER UDP/TCP	RTMP, HTTP, HLS, SRT, RTP, UDP, UNICAST/MULTICAST AND RTSP OVER UDP/TCP
AUDIO INPUT	1x HDMI, 1x 3.5MM JACK	1x SDI, 1x 3.5MM JACK	-
AUDIO OUTPUT	-	-	1x HDMI, 1x SDI, 1x 3.5MM JACK
AUDIO CODEC	AAC/MP3/MP2	AAC/MP3/MP2	-
CONTROL INTERFACE	WEBUI	WEBUI	WEBUI
DIMENSION (W X D X H)	150x105x40MM	150x105x40MM	150x105x40MM

G500

Genesis Streaming & Recording

DESCRIPTION

G501RH/G502RH are the latest Genesis AV-over-IP streaming encoders/decoders, which offers multiple operation modes including encoding, decoding, transcoding, video mixing and recording of video/audio sources up to 4K using H264/H265 video codecs.

Both units support multiple streaming protocols such as RTMP and RTSP, giving user the chance of easy streaming on live platforms like YouTube or decoding using any 3rd party device that supports the corresponding protocol. G501RH/G502RH also support simultaneous external recording via USB stick or SD card while streaming.



G501RH



G502RH

Key Features

- Supports multiple operation modes including encoding, decoding, transcoding, video mixing and recording
- Supports multiple streaming protocols, including RTMP, HTTP, HLS, SRT, RTP, ONVIF, UDP Unicast/Multicast and RTSP over UDP/TCP
- Supports encoding up to 2 HDMI inputs or transcoding up to 4 streams in dual stream channels with a resolution up to 4K
- Supports decoding up to 8 streams and output via HDMI with an up to a 3x3 multiview for display
- Supports mixing of 4 streams and 2 HDMI inputs in a dual encoding channel with one customised layout
- Supports selectable audio input and output between 3.5mm mini jack and embedded audio or a mix of all
- External video storage on USB stick or MicroSD cards
- Supports automatic replacement of old files during continuous recording
- Supports uploading of recordings to FTP servers.
- User-friendly WebUI for configuration
- Flexible power supply: PoE or AC adapters

SPECIFICATIONS

MODEL NAME	G501RH	G502RH
SIMULTANEOUS ENCODING & DECODING	NO	YES
INPUT	1X HDMI	1X HDMI
INPUT RESOLUTION	1080P@60	4K@60
OUTPUT	1X HDMI	1X HDMI
OUTPUT RESOLUTION	1080P@60	1080P@60
ENCODING RESOLUTION	1080P@60	4K@60
ENCODING FORMAT	H264/H265	H264/H265
ENCODING BITRATE	160-20000	16-20000
SIMULTANEOUS ENCODING	4	2
SIMULTANEOUS DECODING	1	8
PROTOCOL	RTMP, HTTP, HLS, SRT, RTP, ONVIF, UDP, UNICAST/MULTICAST AND RTSP OVER UDP/TCP	RTMP,HTTP,HLS,SRT,RTP,ONVIF,UDP UNICAST/MULTICAST AND RTSP OVER UDP/TCP
AUDIO INPUT	1X HDMI, 1X 3.5MM JACK	1X HDMI, 1X 3.5MM JACK
AUDIO CODEC	AAC/MP3	AAC/MP3/OPUS
STORAGE	MICROSD, USB STICK	USB STICK
RECORDING FORMAT	MPEG2-TS	MPEG2-TS
DIMENSION (W X D X H)	180X100X30MM	220X150X25MM

G2000 AV over IP



G2000DEC



G2000ENC



G2000CTL

Key Features

- HDMI 2.0b, HDCP 2.2 compliant
- Input supports up to 4K60 4:4:4, output supports 4K30 4:4:4
- Transmit video, audio, IR, RS-232, CEC and USB signals over Ethernet
- Supports unicast and multicast functions
- Supports point-to-point, video matrix and video wall functions (video wall supports up to 9x9)
- Supports KVM
- JPEG2000 Mainstream and standard H.265 codec Secondary Stream
- Supports PoE function
- Flexible control through Web GUI/TCP/RS-232/IR and third-party controller
- Supports digital and analog audio
- Supports audio embed and de-embed
- Smart networking design for easy and flexible installation

MODELS

MODELS	G2000ENC	G2000DEC	G2000CTL
TYPE	ENCODER	DECODER	Controller

DESCRIPTION

GENESIS™2000 (G2000) is a 4K AVoIP system based on JPEG2000 technology. It allows the distribution of 4K video and audio signal over a network up to lengths of 100m within 1Gb management. The system also supports bi-directional IR, RS-232 & USB and CEC signals over Ethernet.

G2000 system supports both unicast and multicast functions which enable the system to do point-to-point signal distribution, and also allow it to do video matrix and up to 9x9 video wall.

G2000 system uses visually lossless compression technology to deliver 18Gbps signal with virtually no latency. Moreover, G2000 can act like USB hub with USB function allowing the system to be used as a KVM switch and USB data transfer extenders.

SPECIFICATIONS

VIDEO NETWORK BANDWIDTH	1G
VIDEO RESOLUTION	480i ~1080p@50/60Hz, 4K@24/30Hz, support 4K@50/60Hz input
COLOUR SPACE	RGB, YCbCr 4:4:4 / 4:2:2, YUV 4:2:0
COLOUR DEPTH	8-bit, 10-bit, 12-bit
HDMI AUDIO FORMATS	LPCM 2.0/5.1/7.1CH, Dolby Digital/Plus/EX, Dolby True HD, Dolby Atmos, DTS, DTS-96/24, DTS-EX DSD, DTS High Res, DTS-HD Master, DTS:X
POWER SUPPLY	PoE or DC 12V/1A
TRANSMISSION DISTANCE	100M CAT5E/6/6A/7
OPERATING TEMPERATURE	0~40 degrees centigrade
OPERATING HUMIDITY	20%~90% (no condensation)
STORAGE TEMPERATURE	-20~60 degrees centigrade
STORAGE HUMIDITY	10%~90%
CONTROL INTERFACE	TCP/IP control network port/RS232

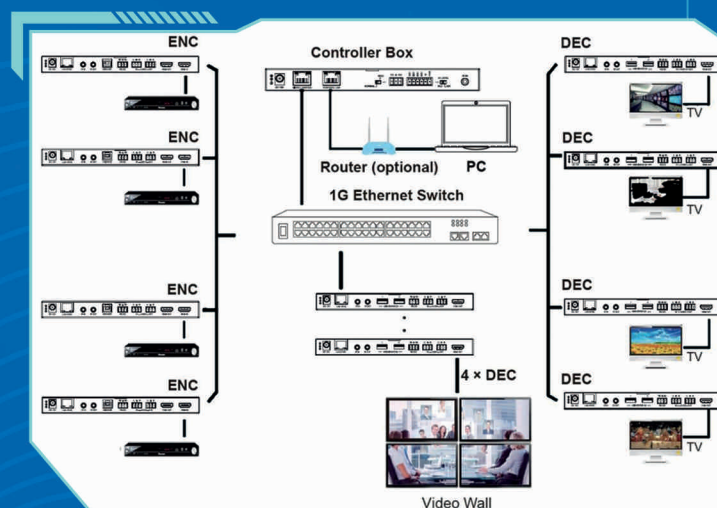

G44

Video Wall Controller



DESCRIPTION

The G44 video wall controller accepts up to 4 HDMI inputs and displays them on 4 different screens, each with a resolution up to 4K@60fps 4:4:4. G44 not only allows the user to display a single input across all four screens, but also to display different input videos onto different screens working like a matrix switcher.

The G44 controller can be easily configured via the front panel, IP/Serial connection to a PC or through 3rd party controllers. Seada offers both a DVI and an HDMI version of the G44.



Key Features

- Four HDMI 2.0 Inputs and Outputs with embedded audio
- Each input and output supports resolutions up to 4K@60Hz 4:4:4
- Supports 180° rotation
- Four digital audio inputs and outputs
- Independent 4x4 IR Matrix
- Supports video wall function
- Presentation switching
- Seamless matrix switching
- CEC Management
- EDID Management
- Custom preset layouts for both Matrix and Video Wall modes
- HDCP compliant
- Customizable OSD
- Exporting and Importing OSD settings
- Adjust display settings remotely (saturation, contrast, etc.)
- Controllable via IP/Serial Port/Remote/Front Panel

SPECIFICATIONS

INPUT RESOLUTION	UP TO 3840 x 2160@60FPS 4:4:4
INPUT FORMAT	HDMI 2.0
OUTPUT RESOLUTION	UP TO 3840 x 2160@60FPS 4:4:4
OUTPUT FORMAT	HDMI 2.0
IR PORT	3.5MM JACK
ANALOG OUTPUT AUDIO INTERFACE	5-WAY PHOENIX CONNECTOR
DIGITAL INPUT AUDIO INTERFACE	MINI TOSLINK JACKETS
ANALOG INPUT AUDIO INTERFACE	3-WAY PHOENIX CONNECTORS
POWER SUPPLY	110-240 VAC
VIDEO WALL CAPABILITIES	YES
CONTROL INTERFACE	10/100/1000M ETHERNET/RS232/Front Panel
MAX POWER CONSUMPTION	60W
DIMENSIONS (IN MM)	480(W) x 245(D) x 44.55(H) 1U

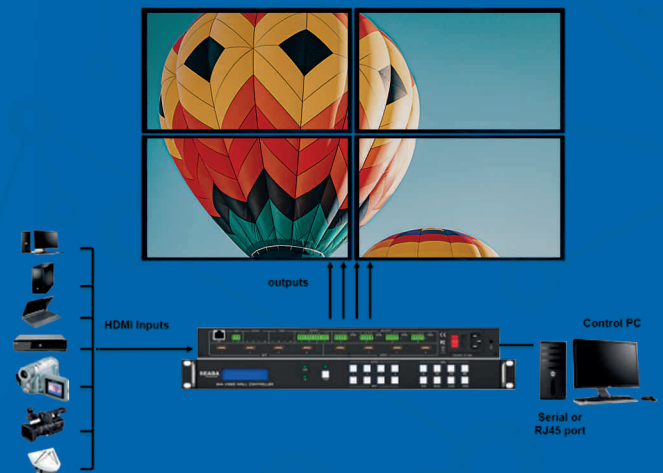



DESCRIPTION

The G88 video wall controller accepts up to 8 HDMI inputs and displays them on 8 different screens, each with a resolution up to 4K@60fps. G88 not only allows the user to display a single input across all eight screens, but also to display different input videos onto different screens working like a matrix switcher.

The G88 controller can be easily configured via the front panel, IP/Serial connection to a PC or through 3rd party controllers.



Key Features

- Eight HDMI 2.0 inputs and outputs with embedded audio
- Supports up to 4K60 4:4:4 inputs and outputs
- Supports 180° rotation
- Supports audio embedding and de-embedding
- Independent 8x8 IR Matrix
- Video Wall capabilities
- Supports scaling on outputs
- Presentation switching capabilities
- Custom preset layouts for both Matrix and Video Wall modes
- Seamless switching
- HDCP compliant
- Customizable OSD
- EDID management
- Adjust display settings remotely (saturation, contrast, etc.)
- Controllable via IP/Serial Port/Remote/Front Panel

SPECIFICATIONS

INPUT RESOLUTION	UP TO 3840 x 2160@60FPS 4:4:4
INPUT FORMAT	HDMI 2.0
OUTPUT RESOLUTION	UP TO 3840 x 2160@60FPS 4:4:4
OUTPUT FORMAT	HDMI 2.0
IR PORT	3.5MM JACK
ANALOG OUTPUT AUDIO INTERFACE	5-WAY PHOENIX CONNECTOR
ANALOG INPUT AUDIO INTERFACE	3-WAY PHOENIX CONNECTORS
POWER SUPPLY	AC 100V TO 240V, -50/60HZ
VIDEO WALL CAPABILITIES	YES
CONTROL INTERFACE	10/100/1000M ETHERNET/RS232/Front PANEL
DIMENSIONS (IN MM)	480(W) x 245(D) x 44.55(H) 1U

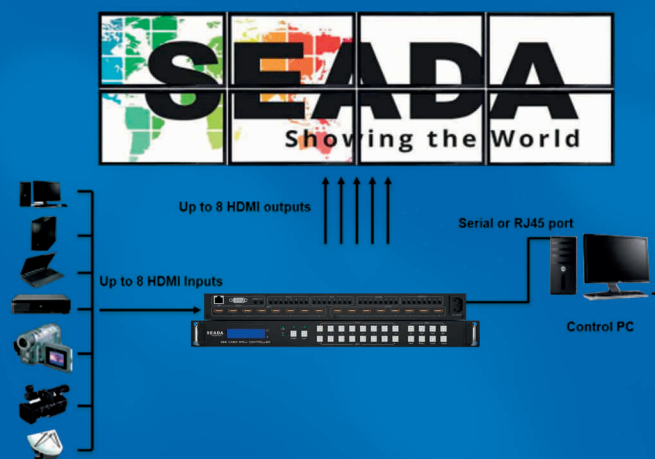

G24

Video Wall Controller



DESCRIPTION

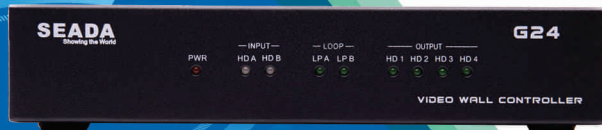

The G24 video wall controller accepts up to 2 HDMI inputs and displays them on 4 different displays, each with a resolution up to 4K@60fps, 4:4:4. G24 not only allows the user to display a single input across all four screens, but also to display different input videos onto different screens working like a matrix switcher.

G24 is able to rotate the output 180 degrees which enables users to form a narrow bezel video wall with low-cost stand TVs.

The G24 Controller can be easily configured via IP/serial port connection to a PC, or through 3rd party controllers.



Key Features

- 2 HDMI 2.0 inputs with embedded audio
- 4 HDMI 2.0 outputs with embedded audio
- Supports 180 degree rotation
- Supports up to 4K60 4:4:4 inputs
- Supports up to 4K60 4:4:4 outputs
- Supports up and downscaling on each output
- Supports daisy chain
- Supports PIP on video wall
- Supports 2 channels HDMI loop out
- Balanced analog audio output
- L/R analog audio output
- Supports audio embedding and de-embedded
- Toslink digital audio outputs
- Supports Bezel Compensation
- Supports CEC management
- Supports EDID management
- Custom pre-set layouts
- HDCP compliant
- Supports adjusting display settings such as Contrast and Saturation remotely
- Controllable via IP/serial port

SPECIFICATIONS

INPUT RESOLUTION	UP TO 3840 x 2160@60fps 4:4:4
INPUT FORMAT	HDMI2.0
OUTPUT RESOLUTION	UP TO 3840 x 2160@60fps 4:4:4
OUTPUT FORMAT	HDMI2.0
ANALOG AUDIO OUTPUT INTERFACE	5-WAY PHOENIX CONNECTORS
DIGITAL AUDIO OUTPUT INTERFACE	MINI TOSLINK JACKETS
AUDIO FORMAT	2.0 CHANNEL, 5.1 CHANNEL, LPCM, DOLBY, AC3, DTS
HDCP	HDCP 2.2
VIDEO WALL CAPABILITIES	YES
CONTROL INTERFACE	10/100/1000M ETHERNET PORT or RS232
DIMENSIONS(W"D"H") (mm)	218mm (W)×146mm (D)×43mm (H)
POWER SUPPLY	12V/3A

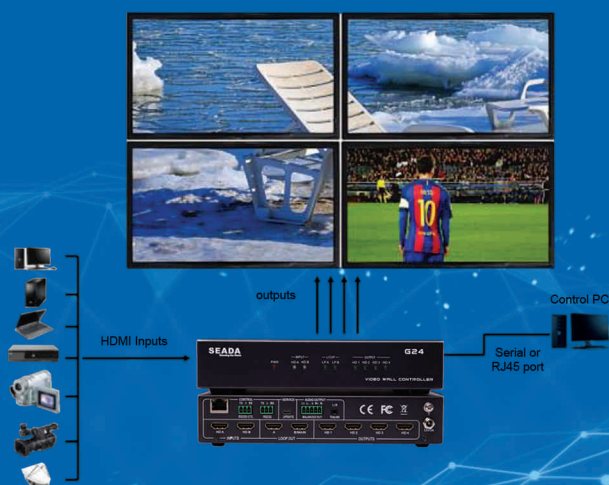

SD-PS-M641

Presentation Switcher

DESCRIPTION

The SD-PS-M641 is a powerful seamless 4K presentation switcher with multiview function. It can take up to 6 video inputs with up to 4K resolution at different formats (HDMI, DP, USB-C) and display them at 4K resolution.

The SD-PS-M641 presentation switcher supports de-embedded input audios and any embedded external audio onto the selected outputs, with line or microphone audio inputs. Scaled video signals are available as HDMI or HDBaseT for a long-distance transmission.

The SD-PS-M641 presentation switcher can be easily controlled via web GUI, front panel buttons, RS232, IR or an 3rd party controller. The unit can run standalone once configured.



Key Features

- 4K 6x1 presentation switcher with multiview ability
- 1 x HDBaseT and 1 mirrored HDMI outputs
- Supports seamless switching
- Supports video source auto or manual switching
- Supports different format inputs
- 4 x HDMI, 1 x DP, 1 x USB-C
- Supports scaling on outputs
- Supports up to 4K and HDCP 2.2 compliant
- Supports up to 40m and 70m transmission distance on 4K and HD signal respectively over HDBaseT output
- HDBaseT output supports 48V PoC
- Supports audio embedded and de-embedded and audio mixing
- Supports Mic/line control input with Phantom Power
- Supports volume control for Mic audio input
- Supports volume control for audio of video sources
- Supports 16 preset layouts and 4 custom layouts

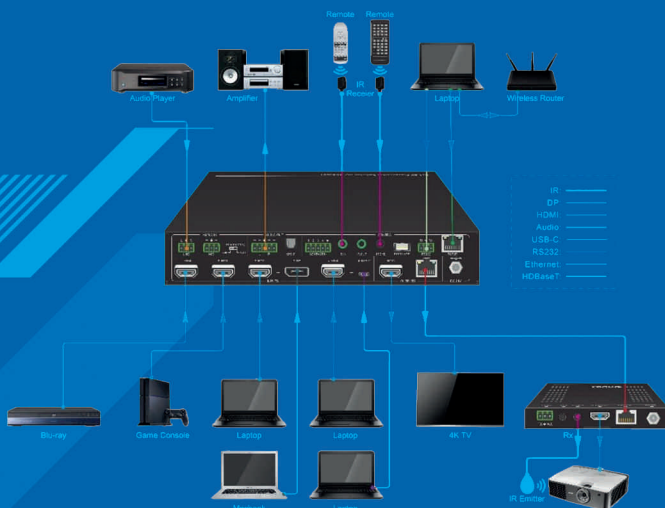

SPECIFICATIONS

DIMENSIONS(W*D*H) (MM)	480MM X 215MM X 44.55MM 1U
NET WEIGHT	1.5KG
INPUT RESOLUTION	UP TO 4K
INPUT FORMAT	HDMI, DP, USB-C
OUTPUT RESOLUTION	UP TO 4K
OUTPUT FORMAT	HDMI, HDBASET
IR PORT	3.5MM JACK
ANALOG AUDIO OUTPUT INTERFACE	5-WAY PHOENIX CONNECTORS
ANALOG AUDIO INPUT INTERFACE	3-WAY PHOENIX CONNECTOR AND 3.5MM JACK
HDCP COMPLIANT	YES
POWER SUPPLY	DC 24V 3A
CONTROL INTERFACE	ETHERNET PORT OR RS232 OR FRONT PANEL OR REMOTE CONTROL
MAX POWER CONSUMPTION	30W



TP-W200 BYOD



TP-U400 BYOM

DESCRIPTION

TP-W200 is a BYOD wireless presentation switcher designed to allow users to bring their own devices (BYOD), such as laptops or mobile devices to share content remotely on a large screen.

TP-U400 is a BYOM wireless presentation switcher designed for ease of use in conference room or classroom applications with less cabling and cost.

Key Features

- Full wireless presentation and BYOM/BYOD support
- Supports wireless input up to 1080P@60Hz, and HDMI 2.0 output up to 4k@60Hz
- Supports Windows/Android application and PnP HDMI/Type-C dongles for wireless connection
- Supports wireless mirroring like Miracast
- Supports USB peripherals like camera, mic, and speaker for wireless connection to PC/laptop (BYOM)
- Supports mouse and keyboard control
- Supports wireless touch back for PC/Android
- Fully compatible with VC platforms
- Supports multiview up to 2(BYOD) or 4 windows with preview (BYOM)
- Supports PoE
- Supports customisable home screen
- Built-in whiteboard and on-screen annotation
- Support WebUI for central management
- Low latency
- Best-in-class data security
- Supports preview

SPECIFICATIONS

MODELS	TP-W200 BYOD	TP-U400 BYOM
OUTPUT	1x HDMI 19-PIN CONNECTOR	1x HDMI 19-PIN CONNECTOR
OUTPUT RESOLUTION	3840x2160@60HZ/30HZ, 1920x1080@60HZ, 1280x720@60HZ	3840x2160@60HZ/30HZ, 1920x1080@60HZ, 1280x720@60HZ
COMPLIANCE	HDMI1.4/HDMI2.0, HDCP1.4/HDCP2.2	HDMI1.4/HDMI2.0, HDCP1.4/HDCP2.2
INPUT RESOLUTION	MAXIMUM 1080P@60HZ VIA TP-DPH/DGC, APP, AND AIRPLAY	MAXIMUM 1080P@60HZ VIA TP-DPH/DGC, APP, AND AIRPLAY
LAN PORT	2x RJ45: 1x 1000MBPS WITH POE, 1x 100MBPS	2x RJ45: 1x 1000MBPS WITH POE, 1x 100MBPS
USER INTERFACE	1x USB3.0, 1x USB2.0, 1x TYPE-C	3x USB3.0, 1x USB2.0, 1x TYPE-C
CONTENT INPUT	TP-DGH/TP-DGC, AIRPLAY, MIRACAST, WINDOWS/MAC APPLICATION	TP-DGH/TP-DGC, AIRPLAY, MIRACAST, WINDOWS/MAC APPLICATION
MULTIVIEW	UP TO 2 SIMULTANEOUSLY WITH ADJUSTABLE LAYOUT	UP TO 4 SIMULTANEOUSLY WITH ADJUSTABLE LAYOUT
NUMBER OF SIMULTANEOUS CONNECTIONS	MAXIMUM 16	MAXIMUM 16
FREQUENCY BAND	2.4 GHZ & 5 GHZ	2.4 GHZ & 5 GHZ
DATA RATE IN WIRELESS	UP TO 1200MBPS	UP TO 1200MBPS
LATENCY	<100MS, MIN 20MS WITH LOW LATENCY MOUSE CURSOR	<100MS, MIN 20MS WITH LOW LATENCY MOUSE CURSOR
POE STANDARD	POE PLUS-1EEE802.3AF	POE PLUS-1EEE802.3AF
DIMENSIONS (MM)	220(W) x 120(D) x 34(H)	165(W) x 95(D) x 25(H)

DONGLES

DESCRIPTION

TP-DGH & TP-DGC are the HDMI and Type C dongles, used for toggling the mirroring from personal PC or Mac onto the main screen via TP-W200 and TP-U400.

Key Features

- Support wireless transmission from PC/Mac to base unit
- Support quick switch of the PC signal for less than 1s by tapping
- Dual colour LED, indicating active source signal and power/link
- Support USB peripherals such as camera, mic, and speaker over Wi-Fi sharing.



TP-DGC-Type C Dongle



TP-DGH HDMI Dongle

SD-MV-CM41

Multiviewers



DESCRIPTION

The SD-MV-CM41 multiviewer is designed to display multi video inputs onto one display. It features four HDMI inputs supporting up to 4K and one HDMI output with resolution up to 4K as well.

It also provides a line input, 1 mix input, 1 SPDIF output and 1 analog output for audio processing.

It is an extremely flexible and seamless switching capable multiviewer making it perfect for applications such as broadcasting, security, boardroom, TV studio and so on.



Key Features

- 4 HDMI inputs, 1 HDMI output.
- Supports 4K@30Hz 4:4:4
- Supports HDCP 2.2
- Seamless switch between 4 input ports
- Auto Scaler in each source input
- Supports audio embedding and mixing
- Supports audio de-embedding
- Auto-switching at single window
- Cycles through the windows from A to D by swap buttons
- Resizes the windows in 3 different sizes
- 16 pre-defined layouts for multi-view
- Supports up to 4 customised preset layouts
- Multiple control methods, including an assignable front panel, IR remote, web GUI and RS232 port.

SPECIFICATIONS

DIMENSION (W X H X D)	285MM x 27MM x 172.5MM
NET WEIGHT	1.24KG
VIDEO INPUT	4 x HDMI
HDMI INPUT RESOLUTION	UP TO 4K@30Hz 4:4:4
VIDEO OUTPUT	1 x HDMI
HDMI OUTPUT RESOLUTION	UP TO 4K@30Hz RGB
HDCP VERSION	UP TO HDCP 2.2
AUDIO IN	1 x LINE IN, 1 x MIX IN
AUDIO OUT	1 x AUDIO OUT, 1 x SPDIF
CONTROLS	1 x RS232, 1 x TCP/IP, 1 x IR REMOTE
POWER SUPPLY INPUT VOLTAGE	INPUT AC 100~240V, 50/60Hz
POWER CONSUMPTION	13W
OPERATING TEMPERATURE RANGE	0~40 DEGREE CENTIGRADE
OPERATING HUMIDITY RANGE	10%~90% NON-CONDENSING

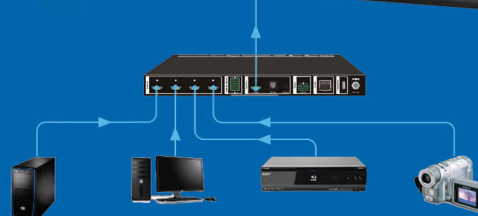

SD-MV-CM61

Multiviewers

DESCRIPTION

The SD-MV-CM61 multiviewer is designed to display multi video inputs onto one display. It features 4 HDMI2.0 and 2 DP1.2 video inputs supporting up to 4K@60 and one HDMI2.0 output with resolution up to 4K@60 as well.

It also provides 6-line inputs, 1 SPDIF output and 1 analog output for audio processing. It is extremely flexible and fast switching capable multiviewer making it perfect for applications such as broadcasting, security, boardroom, TV studio and so on.



Key Features

- 4 HDMI2.0 inputs, 2 DP 1.2 inputs
- 1 HDMI2.0 output.
- Supports 4K@60Hz 4:4:4
- Supports quad view
- Supports HDCP 2.2
- Supports up/down scaling
- Supports video cropping
- Supports 6 embedded audio inputs
- Supports 6 analog audio inputs
- Supports audio embedding
- Supports audio de-embedding
- Supports Auto-switching
- Supports up to 16 pre-defined layouts
- Supports up to 16 custom layouts
- Multiple control methods, including a front panel, web GUI and RS232 port.

SPECIFICATIONS

DIMENSION (W X H X D)	440MM x 272MM x 43.5MM
NET WEIGHT	3.16KG
VIDEO INPUT	4 x HDMI (2.0), 2 x DISPLAY PORT (1.2)
HDMI INPUT RESOLUTION	UP TO 3840x2160 @60HZ
VIDEO OUTPUT	1 x HDMI
HDMI OUTPUT RESOLUTION	UPT TO 4K@60Hz RGB
HDCP VERSION	UP TO HDCP 2.2
AUDIO IN	6 x 3.5MM STEREO JACK, 4 x HDMI (EMBEDDED), 2 x DP (EMBEDDED)
AUDIO OUT	1 x 3.5MM MINI JACK, 1 x OPTICAL FIBER TERMINAL, 1 x HDMI (EMBEDDED)
CONTROLS	1 x RS232, 1 x RJ45, FRONT PANEL, OPERATION GUI
POWER SUPPLY INPUT VOLTAGE	INPUT AC 100~240V, 50/60Hz
POWER CONSUMPTION	13W
OPERATING TEMPERATURE RANGE	0~40 DEGREE CENTIGRADE
OPERATING HUMIDITY RANGE	10%~90% NON-CONDENSING

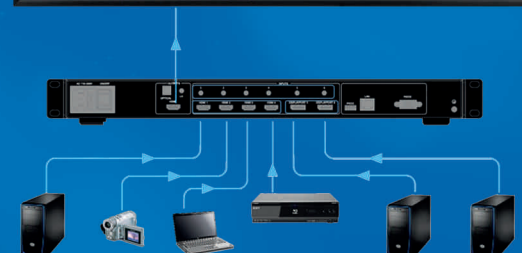
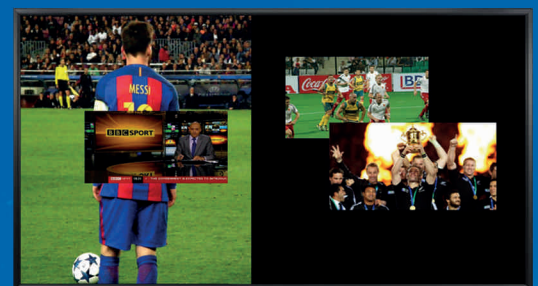

SD-MV

Multiviewers



DESCRIPTION

The SD-MV multiviewers support up to 4 (MV-0401P) or 9 inputs (MV-0901) and one HDMI output.

The SD-MV multiviewers allow the user to view the inputs simultaneously on one screen. The product can be controlled via the front panel button and remote control.



SD-MV-0401P



SD-MV-0901

Key Features

- HDMI outputs support resolutions up to 4K@60Hz
- SD-MV-0401P- 4x HDMI inputs
- SD-MV-0901- 9x HDMI inputs
- Fast seamless switching with scaling up to 3840x2160p (4K)
- Supports 1/2/4/9 windows multi-view modes
- Displays multiple full HD signals within one 4K display with pixel-to-pixel quality
- Control is via on-panel button, IR, RS-232, LAN or Web GUI
- 1U rack mounted design

SPECIFICATIONS

	SD-MV-0401P	SD-MV-0901
COMPLIANCE	HDMI 2.0B, HDCP 2.2 / 1	HDMI 1.4B, HDCP 1.4
VIDEO BANDWIDTH	18GBPS	10.2GBPS
VIDEO RESOLUTION	UP TO 4K2K@60	UP TO 4K2K @ 30HZ
COLOUR SPACE	RGB, YCbCr 4:4:4, 4:2:2, 4:2:0	RGB, YCbCr 4:4:4, 4:2:2
COLOUR DEPTH	8 BIT	8 BIT
AUDIO FORMAT	LPCM 2.0	LPCM 2.0
INPUTS	4X HDMI	9X HDMI
OUTPUTS	1x HDMI, 1x L/R (RCA), 1x OPTICAL (S/PDIF)	1x HDMI TYPE A, 1x AUDIO OUT 3.5MM JACK
POWER SUPPLY	DC 12V/2.5A	DC 12V/1A
DIMENSIONS (MM)	220(W) x 100(D) x 30(H)	440(W) x 200(D) x 44.5(H)
WEIGHT	620G	2.26KG

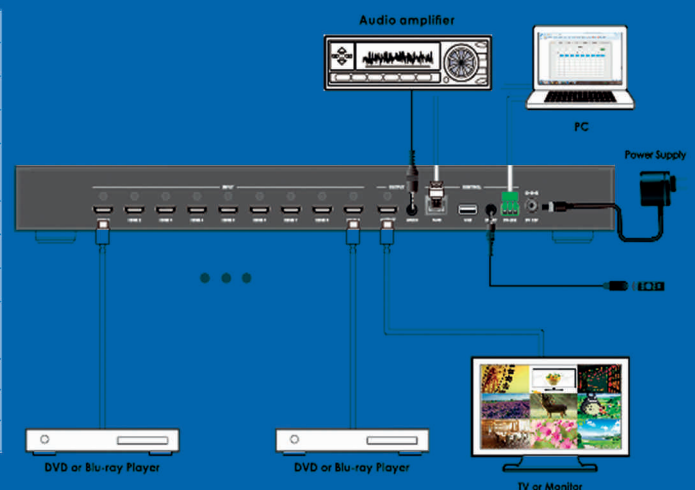

SD-MV-0501P

Multiviewers

DESCRIPTION

SD-MV-0501P is a HDMI 2.0, DP 1.2 and USB C Seamless Video Switcher with Multiview function. It supports 3x HDMI, 1x DP and 1x USB C (video only) inputs, one HDMI and one HDBaseT video mirror output which can send audio & video source onto a CAT cable up to 70 meters.

SD-MV-0501P not only supports the embedded audio on output, but also supports de-embedded audio via the 3.5mm audio jack.



Key Features



- Seamless switching on single display window mode
- Supports 5 Multiview display modes
- Supports up to 20 preset layouts
- Supports customized layouts
- Supports both HDMI and HDBaseT outputs
- Supports HDMI 2.0, DP 1.2 & USB C inputs
- Supports customised resolution at both input and output ports
- Supports output resolution up to 4096x2160P@60Hz
- Extensive EDID and HDCP control
- HDBaseT transmission length up to 70m @1080p, or 40m @4K
- Supports LPCM, AC3, DD+, DTS, DTS-HD format up to 7.1 channel
- Audio extraction, 3.5mm L/R output
- Provide 24V/10watt PoC for HDBaseT receiver
- Auto-switching at single window mode

SPECIFICATIONS

COMPLIANCE	HDMI 2.0, HDCP 2.2
VIDEO RESOLUTION	UP TO 4K@60
OUTPUT SCALING	UP TO 4096x2160@60
AUDIO FORMAT	HDMI: LPCM2.0/5.1/7.1CH, DOLBY DIGITAL PLUS, DTS, DTS HIGH RES ANALOG AUDIO (3.5MM L/R): LPCM2.0
INPUTS	3x HDMI, 1x DP, 1x USB-C
OUTPUTS	1x HDMI, 1x L/R, (3.5MM), 1x HDBT
CONTROL	1x RS232
POWER SUPPLY	DC 24V/1A & PoC FOR HDBT RX
DIMENSIONS (MM)	100(W) x 225(D) x 25(H)
WEIGHT	0.75KG



Matrix Switcher



MS-HV51B

DESCRIPTION

MS-MV51B is a 4K Multi inputs & Multi formats presentation switcher with a built in scaler. It supports 5 inputs of 4x HDMI and 1x VGA (YPbPr, CVBS) and 1 HDMI output.

The input source is capable of switching and scaling to adopt resolution then transmit over HDMI output. The HDTV resolution is achievable. The system can be controlled and configured easily by the panel button, IR remote and RS-232.

Key Features

- Compliant with HDMI 2.0/1.4b, HDCP 2.2/1.4
- Support multi inputs: 4xHDMI, 1xVGA(YPbPr, CVBS)
- Support HDMI input resolutions up to 4K UHD 4:4:4 @50/60
- Support output resolutions up to 4K UHD 4:4:4 @60

- Support two input switching modes: auto or manual
- Support EDID management
- Support pass-through of PCM 2CH
- Device could be controlled via panel button, IR remote and RS-232
- Support USB online software upgrading

SPECIFICATIONS

HDMI COMPLIANCE	HDMI 2.0/1.4B
HDCP COMPLIANCE	HDCP 2.2 AND HDCP 1.4
VIDEO INPUT RESOLUTIONS	HDMI: UP TO 4K2K@50/60HZ (4:4:4) C-VIDEO: PAL/NTSC3.58/NTSC4.43/SECAM/PAL M/ PAL N YPBPR: 480I TO 1080P VGA: 640X TO 1920X1200
HDMI OUTPUT RESOLUTIONS	4K2K60, 4K2K30, 1920x1080P/50, 1920x1080P/60, 1280x720P/50, 1280x720P/60, 1024x768/60, 1280x800/60, 1360x768/60, 1680x1050/60, 1920x1200/60
AUDIO FORMATS	LPCM 2.0CH
INPUT	4x HDMI TYPE A (19-PIN FEMALE) 1x VGA (FEMALE) 1x MICRO USB (5-PIN FEMALE), OPTIONAL FOR POWER SUPPLY)
OUTPUT	1x HDMI TYPE A (19-PIN FEMALE) 1x 3.5MM MINI JAC
CONTROL	1x IR IN 1x RS-232 1x USB SERVICE (UPDATE)
DIMENSIONS	110MM(W) x 288MM(D) x 32MM(H)
POWER SUPPLY	DC 12V/1A ADAPTER (US/EU STANDARDS, CE/FCC/UL CERTIFIED)
POWER CONSUMPTION	9W (MAX)

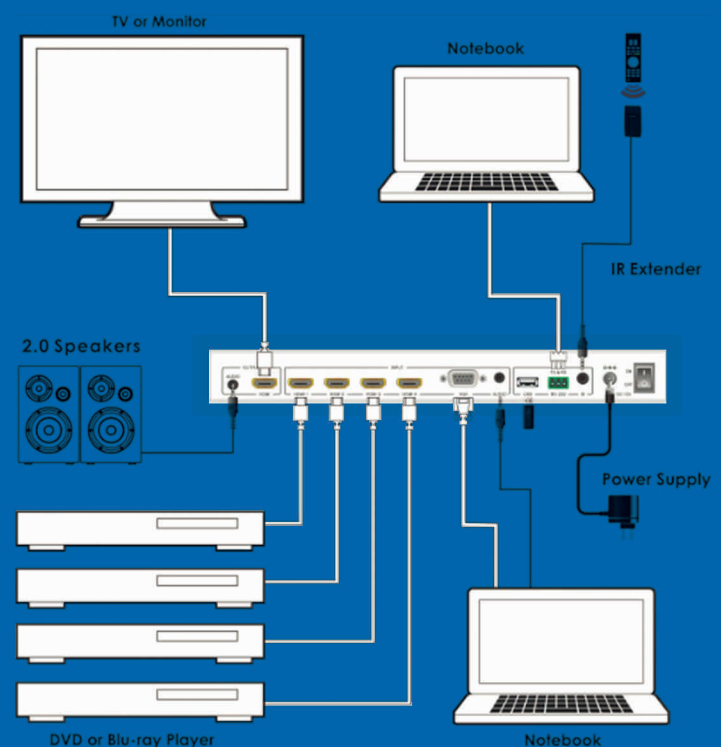

Matrix Switchers

DESCRIPTION

The 6x6 HDMI/HDBaseT matrix supports the transmission of video up to 4K2K@60Hz 4:4:4 and multi-channel digital audio from 6 HDMI sources to 4 HDBaseT outputs and 2 independent HDMI outputs. HDBaseT outputs allow transmission via CAT5e/6/7 cable up to 230 feet/70 meters and the independent HDMI outputs supports cable lengths of up to 33 feet/10 meters. This matrix built-in independent 18x12 digital audio matrix with volume/delay tuning and supports high resolution digital audio formats as well as 3D video content pass-through.

The matrix can be easily controlled via the front panel button, IR, RS-232, Telnet and Web GUI .



MS-HBTB66C70



Key Features

- HDMI 2.0b (18Gbps), HDCP 2.2 and DVI compliant
- Supports resolution up to 4K@60 (YUV 4:4:4) on all HDMI ports
- Supports automatic 4K:60 (YUV 4:4:4) to 4K@60 (YUV 4:2:0) conversion for all HDBaseT outputs
- 4K/2K & 4K UHD signals can be transmitted up to 130 feet/40 meters and 1080P up to 230 feet/70 meters via CAT5e/6/7
- Supports pass-through of HD audio formats: LPCM 2/5.1/7.1CH, Dolby Digital 2/5.1CH, Dolby Digital Plus, Dolby TrueHD, Dolby Atmos, DTS-HD Master Audio and DTS X
- Built-in independent audio matrix with Volume, Mute and Audio delay adjustment for lipsync (LPCM only)
- HDR10, Dolby Vision, ARC, CEC and smart EDID management supported
- 24V PoC on all HDBaseT ports

SPECIFICATIONS

COMPLIANCE	HDMI 2.0, HDCP 2.2, HDR10
VIDEO BANDWIDTH	Up to 18 GBPS
VIDEO RESOLUTION	UP TO 4K2K@50/60Hz (YUV 4:4:4)
HDMI AUDIO (PASS-THROUGH)	LPCM 2/5.1/7.1CH, DOLBY DIGITAL, DTS 5.1, DOLBY DIGITAL+, DOLBY TRUE HD, DTS-HD MASTER AUDIO, DOLBY ATMOS, DTS X
AUDIO FORMATS (OPTICAL/COAXIAL IN)	LPCM 2/5.1/7.1CH, DOLBY DIGITAL, DTS 5.1, DOLBY DIGITAL+
AUDIO FORMATS (ANALOG/COAXIAL OUT)	LPCM 2CH UP TO 192KHz SAMPLE RATE
INPUTS	6x HDMI, 2x AUDIO (3.5MM), 2x OPTICAL AUDIO (S/PDIF), 2x COAXIAL AUDIO (S/PDIF), 8x IR (3.5MM), 4x RS-232 (3PIN PHOENIX), 1x RJ45 (TCP/IP)
OUTPUTS	2x HDMI, 4x RJ45 (HDBaseT), 6x AUDIO (3.5MM), 6x OPTICAL (S-PDIF), 7x IR (3.5MM)
DIMENSIONS (IN MM)	483(W) x 303(D) x 44.5(H)
WEIGHT	2.11KG
PSU	AC 100~240V, 50/60Hz
POWER CONSUMPTION	60W (MAX)

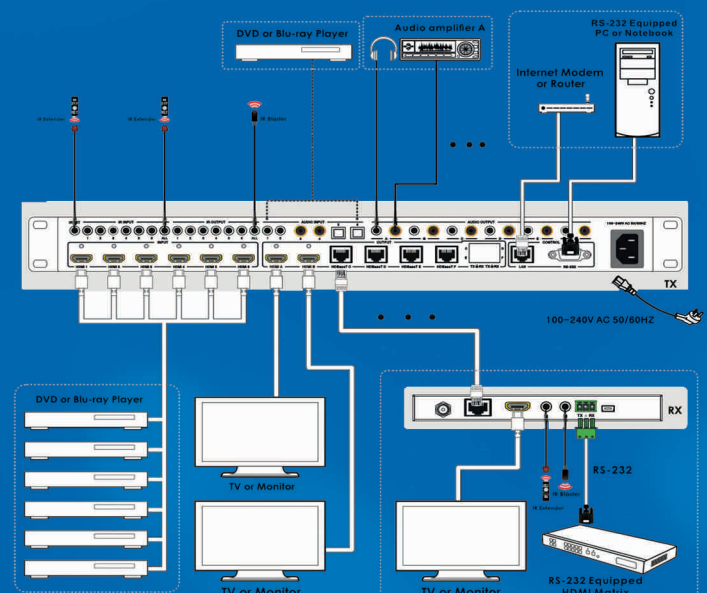



MS-HBT44B70



MS-HBT88B70

DESCRIPTION

HDBaseT 4x4 & HDBaseT 8x8 Matrix Switcher support the transmission of video up to 4K2K@60Hz, and multichannel digital audio from HDMI sources to HDBaseT outputs and independent HDMI output(s).

The HDBaseT outputs allow transmission of video, audio and control signal via a single CAT6/6a cable up to 230ft/70m. The matrix can be controlled via front panel button, IR remote control, RS-232, LAN or Web GUI.



Key Features

- HDMI 2.0b, HDCP 2.2 and HDCP 1.4 compliant
- Up to 4K2K@60Hz (4:4:4) on all HDMI and HDBaseT ports
- Supports pass-through audio up to 7.1 channels of High Definition audio (LPCM, Dolby TrueHD, and DTS-HD Master Audio)
- Digital and analog audio de-embedding from any one of outputs (configurable)
- HDR and smart EDID management supported
- 24V POC on all HDBaseT ports
- Control is via on-panel Button, IR, RS-232, LAN and Web UI

SPECIFICATIONS

MATRIX SWITCHERS	MS-HBT44B70	MS-HBT88B70
COMPLIANCE	HDMI 2.0, HDCP 2.2, HDCP 1.4	HDMI 2.0, HDCP 2.2, HDCP 1.4
VIDEO BANDWIDTH	Up to 18 GBPS	Up to 18 GBPS
MATRIX	INPUT PORTS	INPUT PORTS
	4x HDMI, 6x IR (3.5 MM), 1x RS-232, 1x RJ45	8x HDMI, 9x IR (3.5 MM), 1x RS-232, 1x RJ45
	OUTPUT PORTS	OUTPUT PORTS
	1x HDMI, 3x RJ45 (HDBT), 5x IR (3.5MM), 1x SPDIF, 1x AUDIO (3.5MM)	2x HDMI, 6x RJ45 (HDBT), 9x IR (3.5MM), 1x SPDIF, 1x AUDIO (3.5MM)
RECEIVER	INPUT PORTS	INPUT PORTS
	1x RJ45 (HDBT), 1x IR (3.5MM)	1x RJ45 (HDBT), 1x IR (3.5MM)
	OUTPUT PORTS	OUTPUT PORTS
	1x HDMI, 1x IR (3.5MM), 1x RS-232	1x HDMI, 1x IR (3.5MM), 1x RS-232
DIMENSIONS (IN MM)	TX 360(W) x 160(D) x 35(H) RX 115(W) x 65(D) x 17(H)	TX 440(W) x 320(D) x 44.5(H) RX 115(W) x 65(D) x 17(H)
PSU	DC 24V 1.25A	AC 100-240V AC 50/60Hz

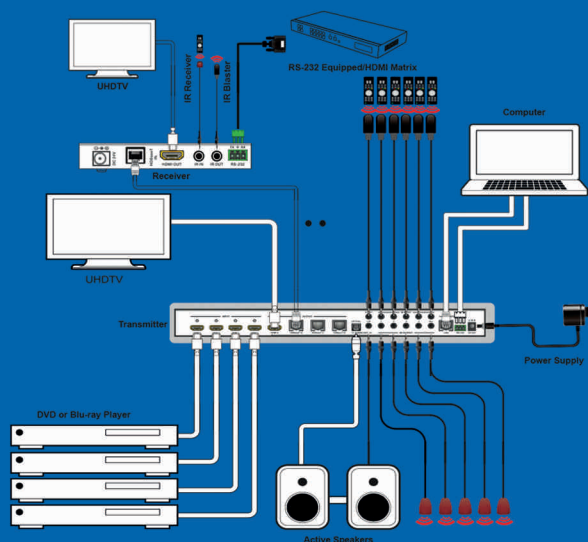

Matrix Switchers

DESCRIPTION

The 18G 8x8 & 4x4 HDMI Matrix over HDBaseT 100m can connect 8/4 HDMI sources to 16/8 displays. It features 8/4 HDMI outputs and each HDMI output is mirrored to provide a CAT-Cable output which runs simultaneously. HDBaseT output can extend video transmission distance up to 330ft / 100m via a single Cat 5e/6/7 cable. The product supports video resolution up to 4K2K @60Hz 4:4:4. Audio de-embedded to analog and coaxial audio is supported. Each HDMI output supports 4K2K to 1080P downscaler independently.

The matrix can be controlled via front panel button, IR remote control, RS-232, LAN or Web GUI.



MS-HBT44B100



MS-HBT88B100



Key Features

- HDMI 2.0b, HDCP 2.2 and HDCP 1.4 compliant
- Up to 4K2K@60Hz (4:4:4) on all HDMI and HDBaseT ports
- 8/4 HDMI inputs, 8/4 HDMI & HDBaseT mirrored outputs
- Support 4K->1080P Down Scaler for each output port
- HDR, HDR10, HDR10+, Dolby Vision, HLG are supported
- Supports pass-through audio up to 7.1 channels of High Definition audio (LPCM, Dolby TrueHD, and DTS-HD Master Audio)
- Audio de-embedded is supported via analog and coax ports
- Advanced EDID management and CEC control are supported
- 24V POC on all HDBaseT ports
- Control is via on-panel Button, IR, RS-232, LAN and Web UI

SPECIFICATIONS

MATRIX SWITCHERS	MS-HBT44B100	MS-HBT88B100
COMPLIANCE	HDMI 2.0; HDCP 2.2; HDR10+	HDMI 2.0; HDCP 2.2; HDR10+
VIDEO BANDWIDTH	Up to 18 GBPS	Up to 18 GBPS
MATRIX	INPUT PORTS: 4x HDMI	INPUT PORTS: 8x HDMI
	OUTPUT PORTS: 4x HDMI; 4x RJ45 (HDBT); 4x COAXIAL AUDIO (3.5MM); 4x 5-PIN PHOENIX (AUDIO)	OUTPUT PORTS: 8x HDMI; 4x RJ45 (HDBT); 8x COAXIAL AUDIO (3.5MM); 8x 8-PIN PHOENIX (AUDIO)
	CONTROLS: 5x IR IN (3.5 MM); 5x IR OUT (3.5 MM); 1x RJ45 (TCP/IP); 1x RS-232	CONTROLS: 9x IR IN (3.5 MM); 9x IR OUT (3.5 MM); 1x RJ45 (TCP/IP); 1x RS-232
RECEIVER	INPUT PORTS: 1x RJ45 (HDBT)	INPUT PORTS: 1x RJ45 (HDBT)
	OUTPUT PORTS: 1x HDMI; 1x AUDIO (3.5MM)	OUTPUT PORTS: 1x HDMI; 1x AUDIO (3.5MM)
	CONTROLS: 1x IR IN (3.5MM); 1x IR OUT (3.5MM); 1x RS-232; 1x MINI-USB (SERVICE)	CONTROLS: 1x IR IN (3.5MM); 1x IR OUT (3.5MM); 1x RS-232; 1x MINI-USB (SERVICE)
DIMENSIONS (IN MM)	TX: 440(W) x 200(D) x 44.5(H) RX: 140(W) x 65(D) x 18(H)	TX: 440(W) x 374(D) x 88.6(H) RX: 140(W) x 65(D) x 18(H)
	PSU	AC 100~240V AC 50/60Hz

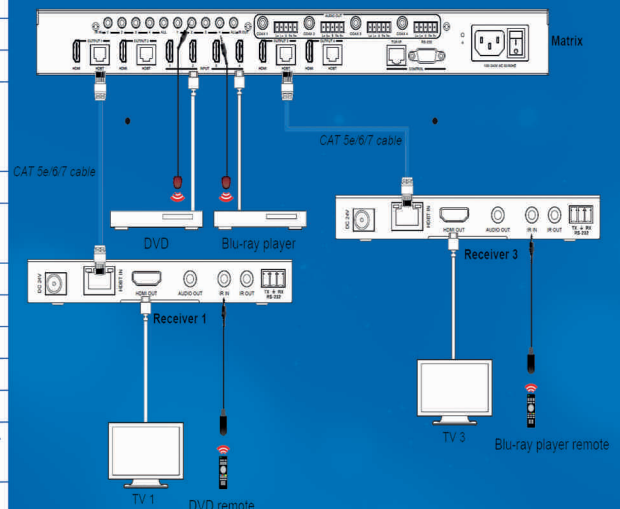



MS-HDM44

DESCRIPTION

MS-HDM44 is a high-performance HDMI Matrix Switcher which can switch any of these four HDMI 2.0 sources to four HDMI 2.0 displays.

Each input and output support up to 4K60 4:4:4 resolution and HDCP 2.2. The outputs can be individually downscaled to 1080p for HD displays.

Key Features

- HDMI 2.0, HDCP 2.2 / HDCP 1.4 and DVI 1.0 compliant
- Four 18G HDMI 2.0 video inputs support up to 4K60 4:4:4 resolution
- Four 18G HDMI 2.0 video outputs support up to 4K60 4:4:4 resolution
- Four outputs can be individually scaled from 4K→1080p

- De-embedded audio to analog L/R and Coaxial ports output
- ARC audio return to the coaxial ports output only
- Built-in Web GUI for TCP/IP control
- Advanced EDID management supported
- Four methods of control: Front panel, RS-232, IR remote and TCP/IP
- Compact design for easy and flexible installation

SPECIFICATIONS

COMPLIANCE	HDMI 2.0, HDCP 2.2 AND HDCP 1.4
VIDEO BANDWIDTH	18GBPS
VIDEO RESOLUTION	4K2K@50/60(4:4:4), 4K2K@50/60(4:2:0), 4K2K@30(4:4:4) 1080P, 1080I, 720P, 720I, 480P, 480I ALL HDMI 3D TV FORMATS, ALL PC RESOLUTIONS INCLUDING 1920x1200
OUTPUT SCALING	4K TO 1080P
COLOUR SPACE	RGB, YCBCR 4:4:4, YCBCR 4:2:2, YCBCR 4:2:0
COLOUR DEPTH	8-BIT, 10-BIT, 12-BIT (1080P, 4K30, 4K60, [YCBCR 4:2:0]) 8-BIT (4K60 (YCBCR 4:4:4))
HDMI AUDIO FORMATS	PCM2.0/5.1/7.1CH, DOLBY DIGITAL/PLUS/EX, DOLBY TRUE HD, DTS, DTS-EX, DTS-96/24, DTS HIGH RES, DTS-HD MASTER AUDIO, DSD
COAXIAL AUDIO FORMATS	PCM2.0, DOLBY DIGITAL/PLUS, DTS 2.0/5.1,
L/R AUDIO FORMATS	PCM 2.0CH
INPUTS	4x HDMI TYPE A (19-PIN FEMALE)
OUTPUTS	4x HDMI TYPE A, 4x L/R AUDIO, 4x COAX AUDIO
CONTROL	1x TCP/IP, 1x RS232, 1x IR EXT
DIMENSIONS (MM)	220(W) x 105(D) x 44(H)
WEIGHT	792G
POWER SUPPLY	DC12V/2.5A

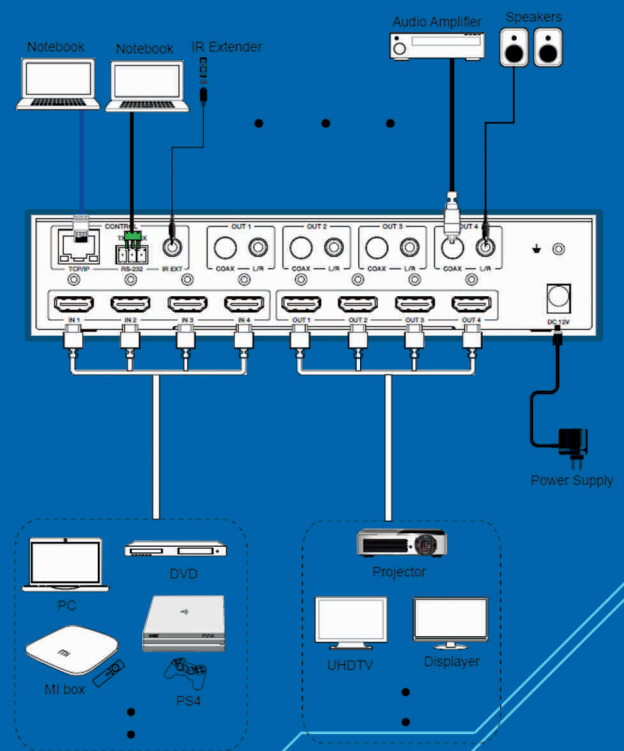

Matrix Switchers

DESCRIPTION

The MS-HDM88 Matrix Switcher offers 4K HDCP 2.2 signals at both input and output ports. It supports the transmission of and multi-channel high resolution digital audio from 8 HDMI sources to 8 HDMI displays.

The MS-HDM88 Matrix Switcher supports both analog and coaxial de-embedded audio at 8 HDMI output ports. When the HDMI output ARC function is enabled, the ARC audio from the HDMI display devices will be extracted to coaxial audio output.

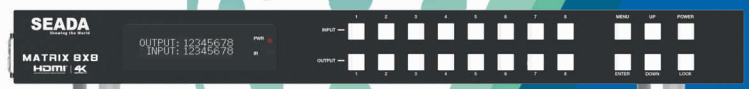

MS-HDM88

Key Features

- Supports HDMI2.0b
- Supports HDCP2.2/1.4
- Supports 8 HDMI inputs and 8 HDMI outputs
- Supports video resolution up to 4K2K@60Hz (YUV 4:4:4) on all HDMI ports
- Supports 18Gbps video bandwidth
- Supports Dolby Vision, HDR10+ and HLG
- Supports 4K→1080p downscaling on each output port
- Supports HDMI audio pass-through up to 7.1CH HD audio (LPCM, Dolby TrueHD and DTS-HD Master Audio)
- Supports audio de-embedded and output on analog and coax ports
- Supports HDMI audio pass-through up to 7.1CH HD audio (LPCM, Dolby TrueHD and DTS-HD Master Audio)
- Supports audio de-embedded and output on analog and coax ports
- Supports ARC, CEC and smart EDID management.
- Control is via on-panel Button, IR, RS0232, LAN and Web GUI
- 1U rack mounted design with front panel OLED display

SPECIFICATIONS

COMPLIANCE	HDMI 2.0, HDCP 2.2 AND HDCP 1.4
VIDEO BANDWIDTH	18GBPS
VIDEO RESOLUTION	UP TO 4K2K@50/60HZ(4:4:4)
COLOUR SPACE	RGB, YCBCR 4:4:4, YCBCR 4:2:2, YCBCR 4:2:0
COLOUR DEPTH	8-BIT, 10-BIT, 12-BIT
HDMI AUDIO FORMATS (PASS-THROUGH)	LPCM 2/5.1/7.1CH, DOLBY DIGITAL, DTS 5.1, DOLBY DIGITAL+, DOLBY TRUEHD, DTS-HD MASTER AUDIO, DOLBY ATMOS, DTS:X
COAXIAL AUDIO FORMATS	LPCM 2.0, DOLBY DIGITAL/PLUA, DTS 5.1
L/R AUDIO FORMATS	PCM2.0
HDR SUPPORT	HDR10, HDR10+, DOLBY VISION, HLG
INPUTS	8X HDMI, 1X IR EXT (3.5MM STEREO MINI-JACK)
OUTPUTS	8X HDMI, 8X COAX AUDIO, 8X L/R AUDIO
CONTROL	1X TCP, 1X RS232
DIMENSIONS(MM)	440(W)X200(D)X44.5(H)
WEIGHT	2.8KG
POWER SUPPLY	DC12V/5A

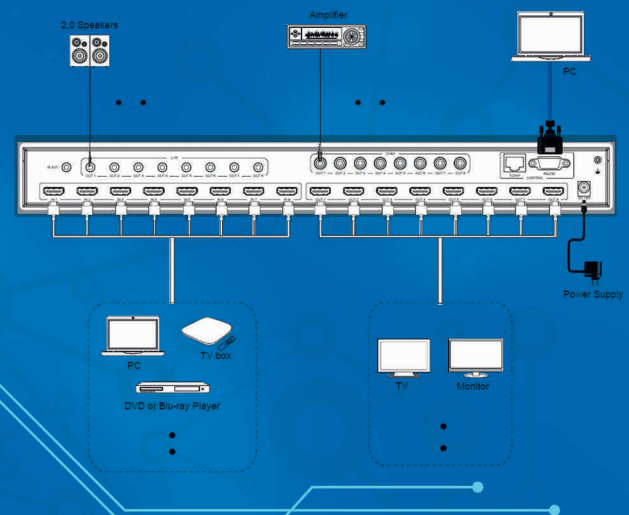



MS-HDM41BA



DESCRIPTION

This is a high performance HDMI 4x1 switcher that supports HDTV formats up to 4Kx2K@60Hz and all HDMI 3D TV formats.

It can extract HDMI stream audio to separate digital and analog audio output.

This product supports HDCP repeater/CEC/ARC functions. Select any of the inputs by front panel button or IR Remote, the corresponding indicator LED on the front panel will be illuminated.

Key Features

- Compliant with HDMI 2.0a, DVI 1.0 standards HDCP 2.2 and HDCP 1.4
- Video formats up to 4Kx2K@60 and all HDMI 3D video formats
- Supports PCM, Dolby TrueHD, DTS-HD Master Audio up to 7.1CH
- Digital and analog audio output
- Supports smart EDID management (Auto/2CH/5.1CH/7.1CH selectable)
- Supports input port auto switching or manual switching mode
- Supports Audio Return Channel (ARC)
- USB2.0 Full-speed transmission and routing
- 12VPOC (Power over Cable) function supported

SPECIFICATIONS

FREQUENCY BANDWIDTH	18 GBPS
INPUT PORTS	4 x HDMI; 1x IR; 1x RS232
OUTPUT PORTS	1x HDMI; 1x L/R; 1x RS232
HDMI AUDIO OUTPUT	PCM2.1/5.1/7.1CH, DOLBY 5.1, DTS5.1, DOLBY-TRUEHD, DTS-HD
DIMENSIONS (IN MM)	180(D) x 85(W) x 11.6(H)
WEIGHT	300G
POWER CONSUMPTION	MAX 2.5W



Conference Solutions

OVERVIEW

SEADA Series Motorized Retractable, Foldable Monitors and Microphones benefit the more traditional Assembly/Chamber set up. Furthermore, it can also be an excellent tool in Meeting/Conference Rooms. By placing attendees around a table with monitors in front of them allows them to easily look at the information/presentation.

SEADA's Conference Solutions range offers Portable Meeting Room System as well. This All in One system features a 13.3" motorised monitor, PC, speaker, microphone, stylish clock and an 8.8" ID TFT built in panel. It can be a perfect solution for schools, receptions and small to large meeting room applications.

Portable Meeting Room System



SC13W



Key Features

- Retractable Monitor
- 0 ~ 60° adjustable monitor angle
- Touch screen
- Built in MIC & speaker
- Built in PC with Windows 10 Pro
- 8.8" TFT ID screen

SPECIFICATIONS

VIEWING ANGLE	0-60°
SCREEN SIZE (INCHES)	13.3
TOUCH SCREEN	YES
BRIGHTNESS	300cd/m ²
CONTRAST	800:1
DISPLAY RESOLUTION	1920x1080
OPERATING SYSTEM	WINDOWS 10 PRO
PROCESSOR	CELERON 3855U 1.6Ghz
SYSTEM MEMORY (RAM)	8G
STORAGE	SSD 64GB
ID SCREEN SIZE (INCHES)	8.8
ID SCREEN RESOLUTION	1280x320
VIDEO PORTS	1x HDMI, 1x VGA
USB	4x USB 3.0
BUILT IN MIC PICK UP DISTANCE	UP TO 100CM

Motorized Retractable Monitors



 **SC13FM**

Key Features

- Motorised retractable monitor
- Fine powder coated surface finish
- Stylish design
- Optimised viewing angle
- Ergonomic design
- Integrated PC power switcher
- HDCP compliance
- Integrated input video sources switcher
- Illuminated capacitive touch buttons
- Compatible with SEADA Multimedia Conference Platform

SPECIFICATIONS

SCREEN SIZE (INCHES)	13.3
VIEWING ANGLE	0-25°
DISPLAY RESOLUTION	1920x1080
TOUCH SCREEN	OPTIONAL
SYSTEM DESKTOP FRAME SIZE	383MM*75MM*3MM
HOUSING DESKTOP CUT SIZE	376MM*69MM
SYSTEM WEIGHT	12KG
SYSTEM DIMENSIONS (WITH FEETS)	520MM*383MM*75MM
SYSTEM SHIPPING WEIGHT	13KG
SYSTEM SHIPPING DIMENSIONS	600MM*420MM*210MM

Motorized Retractable Monitors



 **M Series**

Key Features

- Motorised retractable monitor
- 16 degree of automatic inclination screen
- One button control
- Ergonomic design
- Optional Touch Screen
- Integrated PC power switcher
- Stylish design
- RS485 & remote control

SPECIFICATIONS

MODEL	SC15M	SC17M	SC22M
SCREEN SIZE (INCHES)	15.6	17.3	21.5
VIEWING ANGLE	16°	16°	16°
DISPLAY RESOLUTION	1920x1080	1920x1080	1920x1080
TOUCH SCREEN	OPTIONAL	OPTIONAL	OPTIONAL
SYSTEM DESKTOP FRAME SIZE (IN MM)	435*75*3*4-R10	468*75*3*4-R10	738*95*4*4-R10
HOUSING DESKTOP CUT SIZE	427MM*67MM	460MM*67MM	723MM*87MM
SINK IN DESKTOP CUT SIZE (IN MM)	437*77*3*4-R10	470*77*3*4-R10	740*97*4*4-R10
SYSTEM WEIGHT	12KG	15KG	25KG
SYSTEM HEIGHT (WITH FEETS)	581.8MM	596.8MM	708.8MM
SYSTEM SHIPPING WEIGHT	13KG	16KG	27KG
SYSTEM SHIPPING DIMENSIONS (IN MM)	720*570*190	720*570*190	860*860*210

Conference Solutions

Motorized Retractable Monitors

SPECIFICATIONS

MODEL	SC15G	SC17G
SCREEN SIZE (INCHES)	15.6	17.3
VIEWING ANGLE	0 ~ 90°	0 ~ 90°
DISPLAY RESOLUTION	1920x1080	1920x1080
TOUCH SCREEN	OPTIONAL	OPTIONAL
SYSTEM DESKTOP FRAME SIZE (IN MM)	690*95*4*R10	690*95*4*R10
HOUSING DESKTOP CUT SIZE	684MM*87MM	684MM*87MM
SINK IN DESKTOP CUT SIZE (IN MM)	692*97*4*R10	692*97*4*R10
BUILT IN INDEPENDENT MICROPHONE	YES	YES
SYSTEM WEIGHT	29KG	30KG
SYSTEM DIMENSIONS (IN MM)	724*671*82	724*671*82
SYSTEM SHIPPING WEIGHT	31KG	32KG
SYSTEM SHIPPING DIMENSIONS (IN MM)	880*810*220	880*810*220



Key Features

- Motorised retractable monitor
- 0 ~ 90° adjustable monitor angle
- Touch screen
- Built in motorised retractable microphone
- Ergonomic design
- Integrated PC power switcher
- Stylish design
- RS485 & remote control
- Low power consumption

Motorized & Retractable Tablet

SPECIFICATIONS

OPERATING SYSTEM	WINDOWS 10 PRO
SCREEN TYPE	IPS LCD
BRIGHTNESS	250cd/m ²
TOUCH SCREEN	YES
TABLET OUTPUT PORT	1x HDMI MINI 1.4
TABLET INPUT PORT	2x USB 3.0, MICROPHONE PORT
BASE PORTS	2x USB 3.0, DC IN, ETHERNET
WIRELESS	802 11AC/A/B/G/N, 2.4G + 5G
SCREEN SIZE (INCHES)	13.3
DISPLAY RESOLUTION	1920 x 1080
PROCESSOR	INTEL I3-8130U
SYSTEM MEMORY (RAM)	DDR4 4GB
GRAPHICS CARD	INTEL UHD GRAPHICS 620@1.10GHZ
STORAGE	SSD 64GB
BLUETOOTH	BT 4.2



Key Features

- Ergonomic design
- Optimised viewing angle
- Adjustable viewer angle
- HDCP compliance
- Detachable Tablet
- Auto switching between wireless and Ethernet connection
- Compatible with SEADA Multimedia Conference Platform

Conference Solutions

Motorized Retractable Monitors



✓ W SC17FZD

Key Features

- Motorised foldable design
- 0 ~ 110° adjustable monitor angle
- Touch screen – optional
- Built-in mouse and keyboard housing

SPECIFICATIONS

SCREEN SIZE (INCHES)	17.3
VIEWING ANGLE	0-110°
DISPLAY RESOLUTION	1920x1080
TOUCH SCREEN	OPTIONAL
SYSTEM DESKTOP FRAME SIZE	510MM*392MM*3MM*4-R10
HOUSING DESKTOP CUT SIZE	496MM*378MM
SYSTEM WEIGHT	16KG
SYSTEM HEIGHT (WITH FEETS)	109MM
SYSTEM SHIPPING WEIGHT	18KG
SYSTEM SHIPPING DIMENSIONS	620MM*520MM*210MM
OPERATING HUMIDITY RANGE	10%~90% NON-CONDENSING

Motorized Foldable Monitors

SC 15FZW & SC 17FZW



✓ W

Key Features

- Motorised foldable monitor
- Fine powder coated surface finish
- Stylish design
- Optimised viewing angle
- Touch screen- optional

SPECIFICATIONS

MODEL	SC 15FZW	SC 17FZW
SCREEN SIZE (INCHES)	15.6	17.3
VIEWING ANGLE	100-180°	105-180°
DISPLAY RESOLUTION	1920x1080	1920x1080
TOUCH SCREEN	OPTIONAL	OPTIONAL
SYSTEM DESKTOP FRAME SIZE	429MM*392MM*3MM*4-R10	463MM*345MM*3MM*4-R8.5
HOUSING DESKTOP CUT SIZE	419MM*319MM	453MM*335MM
VIDEO SIGNAL	1x HDMI, 1x VGA	1x HDMI, 1x VGA
CONTRAST	700:1	700:1
BRIGHTNESS	300	300
OPERATING HUMIDITY RANGE	10%~90% NON-CONDENSING	10%~90% NON-CONDENSING

Connectivity Boxes



Key Features

- Multi connectivity ports
- Damping Lid
- Stylish and discreet design
- Sandblasted anodized aluminium top finish
- Wireless charger for smart phones
- Universal power socket is compatible with all sorts of power plugs
- Easy to install and terminate



Key Features

- Multi connectivity ports
- Pneumatic Lift Pop-up Lid
- Stylish and discreet design
- Sandblasted anodized aluminium top finish
- Universal power socket is compatible with all sorts of power plugs
- Easy to install and terminate



Key Features

- Multi connectivity ports
- Pneumatic Lift Pop-up Lid
- Stylish and discreet design
- Sandblasted anodized aluminium top finish
- Universal power socket is compatible with all sorts of power plugs
- Easy to install and terminate



Key Features

- Multi connectivity ports
- Damping retractable Lid
- Stylish and discreet design
- Sandblasted anodized aluminium top finish
- Universal power socket is compatible with all sorts of power plugs
- Easy to install and terminate

SPECIFICATIONS

CONNECTIVITY BOXES	SC-DA	SC-DB	SC-DC	SC-11D
DIMENSIONS (IN MM)	141[W]x150[D]x128[H]	141[W]x150[D]x128[H]	141[W]x150[D]x128[H]	236[W]x125[D]x133[H]
CUT OUT SIZE	φ115MM	φ115MM	φ115MM	215MM x 107MM
CONNECTIVITY PORTS	1x WIRELESS CHARGER TOP, 1x USB, 1x HDMI, 1x RJ45, 1x 3.5mm Jack, 1x UNIVERSAL POWER SOCKET	1x CHARGING USB, 1x HDMI, 1x RJ45, 1x 3.5mm Jack, 1x UNIVERSAL POWER SOCKET	1x CHARGING USB, 1x HDMI, 1x RJ45, 1x 3.5mm Jack, 1x VGA 1x UNIVERSAL POWER SOCKET	1x USB, 1x HDMI, 1x VGA 1x RJ45, 1x 3.5mm Jack, 2x UNIVERSAL POWER SOCKET
POWER INPUT	AC 110V to 250V, 50/60Hz	AC 110V to 250V, 50/60Hz	AC 110V to 250V, 50/60Hz	AC 110V to 250V, 50/60Hz



DESCRIPTION

SDC015 Series PTZ cameras deliver HD video output with excellent sharpness and smoothness, accurately reproducing every detail, colour and therefore awarding users a vivid video experience.

SDC015 cameras apply H.265/H.264 encoding protocols which not only guarantee the motion video with fluent and sharp quality but also small bandwidth requirement.

SDC015 Series PTZ cameras come with different models with different video interfaces (USB, HDMI, SDI, LAN) for video outputs making them ideal for applications of Videoconferencing, Webcasting, Lecture capture, Tele-training, Telemedicine, Security and so on.

Key Features

- High quality 1/2.8" CMOS sensor
- Fast, silent turn and pan function
- Multi output formats (USB, HDMI, SDI, LAN)
- Supports auto-focusing
- Low Noise and High SNR
- Supports H.264/H.265 video compression
- Supports multi network protocols (VISCA, PELCO-D, PELCO-P)
- Supports multiple control interfaces
- Supports remote IR control
- Quiet and smooth PTZ movement
- Supports sleep mode
- Supports up to 255 preset positions
- Supports audio input
- Supports PoE on non-USB models

MODELS

MODELS	OPTICAL ZOOM	DIGITAL ZOOM	VIDEO INTERFACE	NDI	PoE
SDC015-U2U3HL	12X or 20X	10X	USB2.0, USB3.0, HDMI, LAN	NO	NO
SDC015-SHLP	12X or 20X	10X	HDMI, 3G-SDI, LAN	NO	YES
SDC015-SHLPN	12X or 20X	10X	HDMI, 3G-SDI, LAN	YES	YES

SPECIFICATIONS

SENSOR	½.8-INCH-HIGH QUALITY HD CMOS SENSOR
EFFECTIVE PIXELS	16.9 ASPECT, 2.07 MEGAPIXELS
RESOLUTION	UP TO 1920X1080@60
OPTICAL ZOOM	12X OR 20X OPTICAL ZOOM
DIGITAL ZOOM	10X
PAN ROTATION	±170°
TILT ROTATION	-30°~+90°
FOCUS	AUTO/MANUAL
APERTURE	AUTO/MANUAL
ELECTRIC SHUTTER	AUTO/MANUAL
CAMERA CONTROL	VISCA/PELCO-D/PELCO-P
AUDIO INPUT INTERFACE	3.5MM LINEAR INPUT
EXTERNAL POWER SUPPLY	DC12V/2A
WEIGHT	1.4KG

AI Tracking PTZ Cameras

DESCRIPTION

SDC075 AI Tracking PTZ camera has perfect functions, superior performance, and rich video output interfaces including USB, HDMI, SDI and LAN.

It offers vivid and high-resolution videos with a strong sense of depth and fantastic colour rendition. It supports H.264/H.265 encoding which makes motion video more fluent and clearer under low bandwidth conditions.



Key Features

- High quality 1/2.8" CMOS sensor
- Supports full HD resolution
- Leading Auto Focus Technology
- Supports multi output formats (USB, HDMI, SDI, LAN)
- Multiple Audio/Video Compression Standards
- Supports USB3.0 Dual Coding Stream
- Supports multi network protocols (VISCA, PELCO-D, PELCO-P)
- Supports multiple control interfaces
- Supports various remote controls
- Quiet and smooth PTZ movement
- Supports AI Human Detection
- Supports audio input
- Supports PoE

MODELS

MODELS	OPTICAL ZOOM	DIGITAL ZOOM	VIDEO INTERFACE	NDI	POE
SDC075-B20	20x	15x	SDI, USB 3.0, HDMI, LAN	NO	YES
SDC075-B20N	20x	15x	SDI, USB 3.0, HDMI, LAN	YES	YES

SPECIFICATIONS

SENSOR	1/2.8-INCH-HIGH QUALITY HD CMOS SENSOR
EFFECTIVE PIXELS	16:9 ASPECT, 2.07 MEGAPIXELS
RESOLUTION	UP TO 1920X1080@60
OPTICAL ZOOM	20x OPTICAL ZOOM
DIGITAL ZOOM	15x
PAN ROTATION	±170°
TILT ROTATION	-30°~+90°
FOCUS	AUTO/MANUAL
APERTURE	AUTO/MANUAL
ELECTRIC SHUTTER	AUTO/MANUAL
CAMERA CONTROL	VISCA/PELCO-D/PELCO-P
AUDIO INPUT INTERFACE	DIAL CHANNEL 3.5MM LINEAR INPUT
EXTERNAL POWER SUPPLY	DC12V/2.5A
WEIGHT	1.15KG

DESCRIPTION

SDC-TR01 camera control keyboard is designed to work with all PTZ cameras via RS232/422/485 with PELCO-P, PELCO-D or VISCA protocols. Each unit of SDC-TR01 control keyboard incorporates an LCD display, making for professional video conferencing with control of maximum 255 PTZ cameras.

This compact control keyboard is equipped with an ergonomic 4D joystick, allowing adjustment for PTZ camera movements. The intuitive keyboard-style buttons support precise and quick control over various features such as camera switch, focus, exposure, and backlight compensation.

SDC-TR02 control keyboard is the PoE enabled unit to control PTZ cameras either via IP with ONVIF or VISCA or via RS232/422/485 with PELCO-P, PELCO-D or VISCA protocols. One unit of SDC-TR02 control keyboard can be used to control an entire video conferencing system with up to 255 PTZ cameras.

With its 4D joystick and function keys, SDC-TR02 can perform various control operations on the selected PTZ camera devices. Its LCD screen can show the control commands and real-time working status enabling users to know more about the system.



SDC-TR01



SDC-TR02

Key Features

- Supports RS422/485/232 control interfaces
- Supports up to 255 cameras
- Supports VISCA, PELCO-P, PELCO-D, protocol
- Supports VISCA, ONVIF, PELCO-P, PELCO-D, VISCA over IP protocol*
- Supports 4D joystick to control camera PTZ function
- Supports controls of camera rotation, zoom, exposure, focus and so on
- Supports displaying the real-time working status on its LCD display
- Supports recovery from short circuit on RS422 with its over-current protection ability
- Supports up to 1200m communication distance on RS485 (0.5mm Twisted Pair Cable)
- Supports seesaw switch to control zoom speed*
- Supports customised hotkeys on F1+F2*
- Supports control over IP using LAN*
- Supports PoE*
- Supports web browser UI*
- Supports up to 4 cameras shortcut control buttons*

**Features exclusive to SDC-TR02*

SPECIFICATIONS

	SDC-TR01	SDC-TR02
COMMUNICATION METHOD	SERIAL PORT: RS422, RS232, RS485	NETWORK: RJ45. SERIAL PORT: RS422, RS232, RS485
COMMUNICATION PROTOCOLS	SERIAL PORT: VISCA, PELCO-D, PELCO-P	NETWORK: ONVIF, VISCA SERIAL PORT: VISCA, PELCO-D, PELCO-P
COMMUNICATION BAUD RATE	2400, 4800, 9600, 19200	1200,2400,4800,9600,19200,38400,115200
DISPLAY METHOD	BLUE SCREEN LCD SCREEN	BLUE SCREEN LCD SCREEN
DIMENSION	320MM (L) x 180MM (W) x 100MM (H)	320MM (L) x 180MM (W) x 100MM (H)

DESCRIPTION

SDC-AV4K is the premium USB All-in-One video bar which has built-in camera, microphone, and speakers. SDC-AV4K integrates audio & video with the AI intelligent algorithms to offer features of face detection, audio source perfection, voice tracking and so on. Making it an ideal solution for small and medium-sized meeting rooms.

With its auto framing technology, SDC-AV4K is able to automatically adjust the video window based on the participants/position's changes. Its voice tracking ability enables the unit to detect the position of speaker and adjust the zoom/PTZ of the camera automatically to capture the presence of the speaker.



SDC-AV4K

Key Features

- Built in camera, speakers, and microphone
- Supports 120-degree large FOV
- Supports 4K camera resolution
- 8-megapixel high-quality CMOS image sensor
- Supports auto framing
- Supports 5x zoom / ePTZ
- Built in 6 arrays of microphone
- Supports up to 6 meters pickup range
- Supports voice tracking
- Built in 2 x 7W speakers
- Supports 1x USB 3.0 with 2.0 compatibility
- Supports IR remote control

SPECIFICATIONS

SENSOR	1/2.8-INCH 9 MEGAPIXEL HIGH QUALITY HD CMOS SENSOR
AUTO FRAMING	FACE DETECTION & SOUND LOCATION & VOICE TRACKING
FOV	120°
DIGITAL ZOOM	5x
MICROPHONE	6 DIGITAL MICROPHONE ARRAYS
MICROPHONE PICK UP DISTANCE	UP TO 6 METERS
AUDIO PROCESSOR	AEC & AGC & ANS & VOICE LOCALIZATION
CONTROL	IR REMOTE CONTROL
USB INTERFACE	1*USB3.0, TYPE B, (COMPATIBLE WITH USB2.0)
AUDIO INPUT INTERFACE	3.5MM LINEAR INPUT

Wall Plates Control Panels

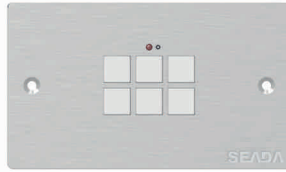

SDCP6



SDCP7



SDCP10

DESCRIPTION

This Wall Plate Control Panel is one of the latest SEADA products for a total AV solution. The Programmable Control Panel can fully control the compatible switches, as well as third-party devices such as matrix switcher, compact scaler switcher, projectors, screens, etc. Use the device for presentations in showrooms, classrooms, and boardrooms.

The SDCP10 is a wallplate control panel with built-in PoE, it can receive power from PoE enabled ethernet switch. This function is providing a simple and economic control solutions.



Key Features

- SDCP6–Sends bi-directional RS232, IR or TCP/IP commands simultaneously to control third party devices.
- SDCP7–Six customizable buttons and one volume control knob.
- SDCP10–Each button can be programmed to send RS232, IR or TCP/IP commands simultaneously to control third party devices.
- SDCP7 & SDCP10–Supports the POE function.
- Units may be programmed through the ETHERNET port, via the Control Software or web GUI.
- Crystal and backlit buttons with easy user-friendly customizable changeable labels.
- The backlit brightness is controllable.

SPECIFICATIONS

CONTROL PANEL	SDCP6	SDCP7	SDCP10
DIMENSIONS (IN MM)	151[W]x 80[D]x 41[H] (EU)	86[W]x 86[D] x 50.5[H] (EU)	86[W]x 86[D]x 36[H] (UK, EU)
	146[W]x86[D] x37[H] (UK)	86[W]x86[D] x50.5mm[H] (UK)	45[W]x106[D] x36[H] (US)
PROGRAM PORT	TCP/IP	TCP/IP	TCP/IP
OUTPUT PORT	3x RS232, 2x IR, 1x RJ45	2 X RS232, 1 X IR, 2 X RELAY	1x RS232, 1x RJ45
BAUD RATE	2400, 4800, 9600, 19200, 38400, 56000, 57600, 115200	9600, 9600, 19200, 57600, 115200	9600, 19200, 38400, 56000, 57600, 115200

Wall Plates HDBaseT Extenders

DESCRIPTION

SEADA's Wall Plate HDBaseT Extenders are 3x1 Wallplate Transmitter Switchers.

The **SD-WP31V** is a 3x1 Wallplate Transmitter Switcher, which is designed to switch and extend HDMI or VGA input signal to far-end display device, and the transmission distance is up to 131ft/40m at 4K and 229ft/70m at 1080P video by using a single CATx cable.

The **SD-WP31C** is a 3x1 Wallplate Transmitter Switcher, which is designed to switch and extend HDMI or Slimport input signal to far-end display device, and the transmission distance is up to 131ft/40m at 4K and 229ft/70m at 1080P video by using a single CATx cable.

The **SD-WP31D** is a 4K HDBaseT Wall-plate that supports one HDMI input, one DP input and one VGA with audio input within a standard medium 86mmx86mm wall box. The HDBaseT port over a single Cat6/6a cable extends distance up to 229.6ft / 70m with 1080p60Hz and up to 131.2ft / 40m with 4K30 YCbCr 4:4:4.

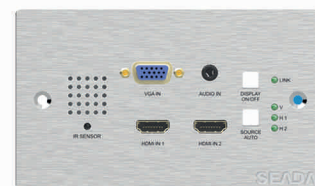

SD-WP31V

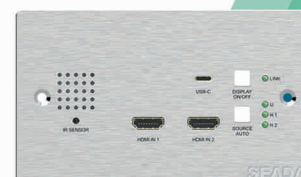

SD-WP31C



SD-WP31D

Key Features

- Supports HDMI signal up to 4K@60Hz 4:2:0
- Supports HDMI 1.4 standard and HDCP 2.2 compliant. Ensures display of content protected media and interoperability with other HDCP compliant devices
- Extending HDMI signal 4K@60Hz up to 131ft/40m and 1080P@60Hz up to 229ft/70m.
- Supports RS232 pass-through with HDBaseT connection and local control
- Supports IR pass-through to extend IR signal to control display device
- The DISPLAY ON/OFF button can be programmed by IR learning feature or RS232 command.
- The HDBT port supports 24V-48V PoC input and is compatible with 48V PoH, the switcher can be powered from the compatible HDBaseT receiver by the CATx cable, and it also supports 24V PoC output.
- Firmware upgrade by Micro-USB port
- HDMI 1.4, HDCP 1.4 and DP 1.2 compliant*

*Exclusive to SD-WP31D

SPECIFICATIONS

MODEL NAME	SD-WP31V	SD-WP31C	SD-WP31D
INPUT	2x HDMI, 1x VGA, 1x 3.5MM MINI JACK	2x HDMI, 1x USB-C (SLIMPORT)	1x HDMI, 1x DP, 1x VGA, 1x 3.5MM MINI JACK
INPUT RESOLUTION	HDMI-4K@60HZ 4:2:0	HDMI-4K@60HZ 4:2:0	HDMI/DP- 4K2K@30HZ 4:4:4 VGA- 1920X1200@60HZ 4:2:2
OUTPUT	1x RJ45 (HDBASET)	1x RJ45 (HDBASET)	1x RJ45 (HDBASET)
OUTPUT RESOLUTION	4K@60HZ 4:2:0	4K@60HZ 4:2:0	4K@30HZ 4:4:4
CONTROL PORTS	1x IR, 1x MICRO-USB, 1x RS232	1x IR, 1x MICRO-USB, 1x RS232	1x RS232
BANDWIDTH	10.2GBPS	10.2GBPS	10.2GBPS
TRANSMISSION DISTANCE	4K@60HZ≤40M, 1080P@60HZ≤70M	4K@60HZ≤40M, 1080P@60HZ≤70M	4K@60HZ≤40M, 1080P@60HZ≤70M
COMPLIANCE	HDMI 1.4, HDCP 2.2	HDMI 1.4, HDCP 2.2	HDMI 1.4, HDCP 1.4, DP 1.2
DIMENSIONS (MM)	151(W)x 80(D) x 39(H) (EU) 146(W) x 86(D) x 39(H) (UK)	151(W) x 80(D) x 39(H) (EU) 146(W) x 86(D) x 39(H) (UK)	86(W) x 86(D) x 41(H) (UK)

HDBaseT Extenders



DESCRIPTION



HBT70S

HBT70S-KIT HDBaseT extender is a transmitter and receiver set used for the transmission of uncompressed HDMI audio video signal over the CAT-5 or CAT-6/7 cable. The transmission resolution can be up to 3840 x 2160 @30Hz 4:4:4, 4096 x 2160 @24Hz 4:4:4, or 4K@50/60Hz 4:2:0.

This HDMI extender uses the advanced technology of HDBaseT to extend uncompressed 1080p or 4K video signals to an 70m or 40m distance respectively over a single Cat cable.



HBT70B

HBT70B-KIT HDBaseT extender provides the ability to deliver HDMI2.0 @4K60Hz 4:4:4 with 18Gbps bandwidth over incredible distance using HDBaseT technology.

They also support HDR, HDCP2.2 and latency free. The Extenders support bi-directional IR and RS232 signals for control applications as well as PoC (Power over Cable).



Key Features

HBT70S

- Complies with the HDBaseT specifications
- Supports 4K UHD video up to 40m (3840 x 2160 @30Hz 4:4:4, 4096 x 2160 @24Hz 4:4:4, and 4K@50/60Hz 4:2:0)
- Supports 1080P @60Hz 36bit; 3D 1080P@30Hz 36bit up to 70m
- HDCP2.2 compliant
- Supports HDMI Audio Formats LPCM, Dolby and DTS.
- Supports bidirectional PoC (Power over Cable), RS232 and Infrared control signal together with HDMI signal
- 10.2 Gbps Bandwidth

HBT70B

- HDMI 2.0b (18Gbps), HDCP 2.2 and DVI compliant
- Video resolutions up to 4K2K@50/60Hz (YUV4:4:4) at 40 meters and 1080p at 70 meters
- 10bits HDR (High Dynamic Range) pass through
- Supports HDMI High Bit Rate (HBR) audio pass through
- Supports CEC bypass
- Supports HDMI Audio Formats LPCM, Dolby and DTS.
- PoC (Power over Cable) function is supported.
- Supports bidirectional RS232 and Infrared control signal together with HDMI signal

SPECIFICATIONS

HDBASET	HBT70S	HBT70B
VIDEO RESOLUTIONS	UP TO 4K2K@30HZ	UP TO 4K2K@50/60HZ
COLOUR SPACE	RGB, YCBCR 4:4:4, YCBCR 4:2:2	RGB, YCBCR 4:4:4, YCBCR 4:2:2
BANDWIDTH	10.2 GBPS	18 GBPS
RECEIVER	HBT70S-RX	HBT70B-RX
INPUTS	1x RJ45, 1x IR RX, 1x PHOENIX	1x RJ45, 1x IR RX, 1x PHOENIX, 1x MINI-USB
OUTPUTS	1x HDMI, 1x IR, 1x PHOENIX	1x HDMI, 1x IR
PSU	DC 24V 1A or PoC	DC 24V 1A or PoC
DIMENSIONS (IN MM)	115(W) x 65(D) x 17(H)	157(W) x 90(D) x 20(H)
TRANSMITTER	HBT70S-TX	HBT70B-TX
INPUTS	1x HDMI, 1x IR, 1x PHOENIX	1x HDMI, 1x IR, 1x PHOENIX, 1x MINI-USB
OUTPUTS	1x RJ45 (HDBASET), 1x IR, 1x PHOENIX	1x RJ45 (HDBASET), 1x IR
PSU	DC 24V 1A or PoC	DC 24V 1A or PoC
DIMENSIONS (IN MM)	115(W) x 65(D) x 17(H)	156(W) x 90(D) x 20(H)

HDBaseT Extenders

DESCRIPTION

HBT100B-KIT & HBT150B-KIT is the HDMI2.0 18Gbps extender equipped with the latest HDBaseT technology, which can extend high definition or 4K video/audio signal, RS232, bi-directional IR between transmitter and receiver via a single CAT cable.

HBT150B-KIT is engineered especially for high-resolution, HDMI-compatible devices with HDMI connectors.

This HDMI extender uses the advanced technology of HDBaseT to extend uncompressed 1080p or 4K video signals to an 150m or 120m distance respectively over a single category cable.



HBT100B



HBT150B



Key Features

HBT100B

- HDMI 2.0b (18Gbps), HDCP 2.2 and DVI compliant
- Video resolutions up to 4K2K@50/60Hz (YUV4:4:4)
- Supports up to 100m transmission for 1080P
- Supports up to 120m transmission for 4K2K
- Supports HDR and HBR audio pass through
- Supports CEC bypass
- Supports HDMI Audio Formats LPCM, Dolby and DTS
- PoC (Power over Cable) function is supported
- Supports bidirectional RS232 and Infrared control signal together with HDMI signal

HBT150B

- HDMI 2.0b (18Gbps), HDCP 2.2 and DVI compliant
- Video resolutions up to 4K2K@50/60Hz (YUV4:4:4)
- Supports up to 150m transmission for 1080P
- Supports up to 120m transmission for 4K2K
- Supports HDR, HDR10+, Dolby Vision and HLG
- Supports HDMI Audio Formats LPCM, Dolby and DTS
- PoC (Power over Cable) function is supported
- Supports bi-directional IR, RS-232 and CEC pass-through

SPECIFICATIONS

HDBASET	HBT100B	HBT150B
VIDEO RESOLUTIONS	UP TO 4K2K@50/60Hz	UP TO 4K2K@50/60Hz
COLOUR SPACE	RGB, YCBCR 4:4:4, YCBCR 4:2:2	RGB, YCBCR 4:4:4, YCBCR 4:2:2
BANDWIDTH	18 GBPS	18 GBPS
RECEIVER	HBT100B-RX	HBT150B-RX
INPUTS	1x RJ45 (HDBASET), 1x IR, 1x RJ45 (ETHERNET), 1x PHOENIX, 1x MINI-USB	1x RJ45 (HDBASET), 1x IR, 1x RS-232, 1x MINI-USB
OUTPUTS	1x HDMI, 1x IR	1x HDMI, 1x IR, 1x3.5mm Jack
PSU	DC 24V 1A or PoC	DC 24V 1A or PoC
DIMENSIONS (IN MM)	157[W] x 90[D] x 20[H]	140[W] x 65[D] x 18[H]
TRANSMITTER	HBT100B-TX	HBT150B-TX
INPUTS	1x HDMI, 1x IR, 1xPHOENIX, 1xMINI-USB, 1x RJ45 (ETHERNET)	1x HDMI, 1x IR, 1x RS-232, 1xMINI-USB
OUTPUTS	1x RJ45 (HDBASET), 1x IR	1x RJ45 (HDBASET), 1x HDMI, 1x IR
PSU	DC 24V 1A or PoC	DC 24V 1A or PoC
DIMENSIONS (IN MM)	157[W] x 90[D] x 20[H]	140[W] x 65[D] x 18[H]

FO-F02P

HDMI over Optical Fibre Extender with Audio Extracting



DESCRIPTION

FO-F02P HDMI Fibre Optical Extender can transmit HDMI signal up to 10 km (over single-mode fibre cable). It supports video resolution up to 4K2K@60Hz 4:4:4.

Its transmitter supports loop output, audio embedding and EDID management function. And its receiver supports audio extracting function.

In addition, the extender supports bidirectional IR control and RS-232 signal pass-through. It can allow users to easily control the display device on the signal source side or control the signal source device on the display side when using this extender.



Key Features

- Supports HDMI 2.0b, HDCP 2.2 and DVI1.0 compliant
- Supports 18Gbps video bandwidth
- Supports video resolution up to 4k2k@50/60Hz 4:4:4
- Supports HDMI audio formats: LPCM2/5.1/7.1CH, Dolby Digital/Plus/EX, Dolby True HD, DTS, DTSEX, DTS-96/24, DTS High Res, DTS-HD Master Audio, DSD
- Supports 3D and HDR format video
- Supports Transmission distance up to 10 km (over single-mode fibre cable)
- Supports bidirectional IR control, RS-232 passthrough and EDID management for simple and convenient control

- Supports loop output (sharing local HD video and audio) and audio embedding function on transmitter
- Supports audio extracting output function on receiver
- Compact design for easy and flexible installation

SPECIFICATIONS

HDMI COMPLIANCE	HDMI 2.0B
HDCP COMPLIANCE	HDCP 2.2
VIDEO BANDWIDTH	18GBPS
VIDEO RESOLUTION	4800i ~1080p50/60Hz, 4Kx2K@24/30Hz, 4k2k@60Hz
COLOUR SPACE	RGB, YCbCr 4:4:4 / 4:2:2, YUV 4:2:0
COLOUR DEPTH	8/10/12-BIT (1080P60HZ)
IR FREQUENCY	20KHz-60KHz
RS-232 BAUD RATE	4800-115200BPS
ESD PROTECTION	HUMAN BODY MODEL:±8kV (AIR-GAP DISCHARGE) & ESD PROTECTION ±4kV (CONTACT DISCHARGE)
POWER SUPPLY	INPUT: AC 100-240V 50/60Hz, OUTPUT: DC 5V/1A
OPERATING TEMPERATURE	0-40°C
STORAGE TEMPERATURE	-20-60°C
RELATIVE HUMIDITY	20-90% RH (NO CONDENSATION)

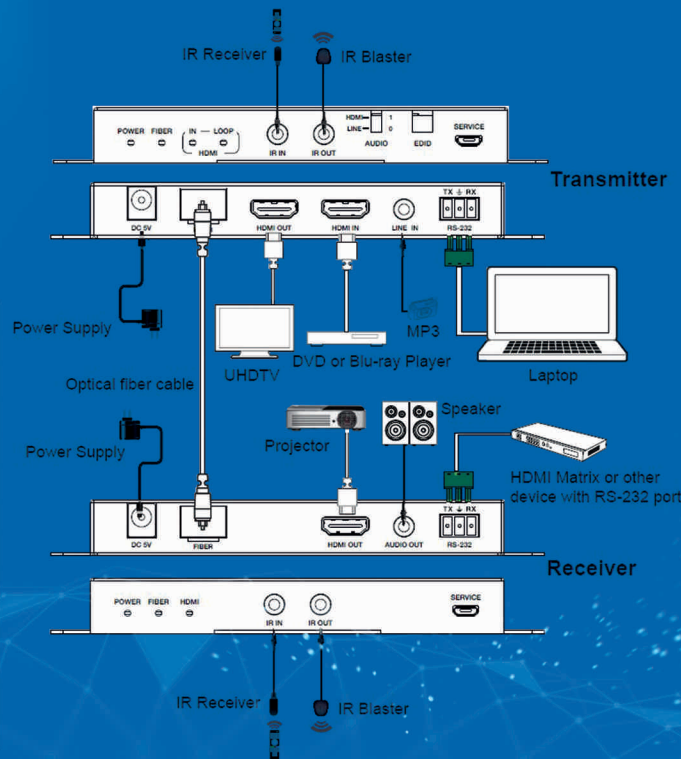

USB Extenders

DESCRIPTION

The SD-USB50 & SD-USB100 USB 2.0 Extenders can transmit USB signal up to 50m/164ft and 100m/328ft via Cat 5e/6 cable.

Users can remotely get access to the USB devices by connecting the transmitter to a PC via its USB-B port and connecting the receiver with USB devices through the two USB ports.



Key Features

- Support USB 2.0 protocol, transmission rate is up to 200Mbps
- Transmission distance is up to 50m/164ft and 100m/328ft via a single CAT5e/6 cable
- Support one USB-B port input on the transmitter
- Support two USB 2.0 ports output on the receiver
- Support PoC function which means that either transmitter or receiver is powered
- Simple plug and play
- Compact design for easy and flexible installation to 5.1 channel

SPECIFICATIONS

DIMENSIONS (WxDxH)	TRANSMITTER/RECEIVER: 82MM x 49MM x 20MM
NET WEIGHT	TRANSMITTER/RECEIVER: 100G
USB PROTOCOL	USB2.0
TRANSMISSION RATE	UP TO 480MBPS(USB50) or 200MBPS(USB100)
TRANSMISSION DISTANCE	50M(USB50) OR 100M(USB100)
TRANSMISSION CONNECTIONS	USB50: INPUT PORT: 1x USB(USB-B, FEMALE) OUTPUT PORT: 1x CAT (RJ45, FEMALE) USB100: INPUT PORT: 1x USB (USB-B, FEMALE) OUTPUT PORT: 1x CAT (RJ45, FEMALE):
RECEIVER CONNECTIONS	USB50: INPUT PORT: 1x CAT (RJ45, FEMALE) OUTPUT PORT: 2x USB (USB-A, FEMALE) USB100: INPUT PORT: 1x CAT (RJ45, FEMALE) OUTPUT PORT: 2x USB (USB-A, FEMALE)
POWER SUPPLY	USB50: INPUT: AC 100 250V 50/60HZ OUTPUT: DC 5V/1A USB100: INPUT: AC 100 240V 50/60HZ OUTPUT: DC 12V/1A
POWER CONSUMPTION	USB50: TRANSMITTER: 0.7W, RECEIVER: 1W USB100: TRANSMITTER: 1.3W, RECEIVER: 2.3W

Splitters



SP-H18B

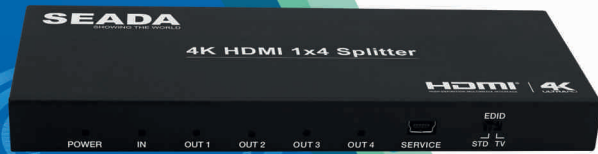

SP-H14B

DESCRIPTION

The SP-H14B and the SP-H18B are an advanced solution for splitting a single HDMI signal to 4/8 HDMI displays synchronously. They provide high performance audio and video output through HDMI cables up to 4K2K@60Hz 4:4:4 and can receive and transmit up to 18Gbps of bandwidth with no data loss.



Key Features

SP-H18B

- HDMI 2.0b, HDCP 2.2 compliant
- Supports 18Gbps bandwidth
- Supports resolution up to 4K@60Hz 4:4:4
- Supports HDR function
- Supports COPY/AUTO EDID control via dialling the dip switch
- Compact design for easy and flexible installation

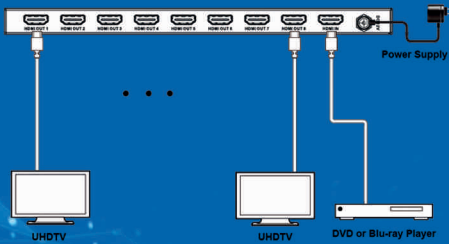

Key Features

SP-H14B

- HDMI 2.0b, HDCP 2.2 compliant
- Supports video format up to 4K2K@60Hz with 8 bit RGB/YCBCR 4:4:4/YCBCR 4:2:2
- Supports 3D frame sequential video format up to 4K2K@30Hz
- Supports high resolution VESA mode video format up to QSXGA@60Hz
- Supports LPCM 7.1CH, Dolby TrueHD, and DTS-HD Master Audio
- Supports smart EDID control
- Compact design for an easy and flexible installation

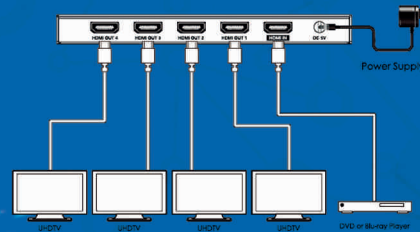

SPECIFICATIONS

SPLITTERS	SP-H14B	SP-H18B
VIDEO RESOLUTIONS	480i ~1080p50/60Hz, 4Kx2K@24/30Hz, 4k2k@60Hz	480i ~1080p50/60Hz, 4Kx2K@24/30Hz, 4k2k@60Hz
BANDWIDTH	600MHz/18GBPS	600MHz/18GBPS
INPUTS	1x HDMI	1x HDMI
OUTPUTS	4x HDMI	8x HDMI
COMPLIANCE	HDMI 2.0B, HDCP 2.2	HDMI 2.0B, HDCP 2.2
DIMENSIONS (IN MM)	63[W] x 163[D] x 16[H]	243[W] x 102[D] x 16[H]
PSU	DC 5V 1A	DC 12V 1A

Splitters

DESCRIPTION

The SD-0102-4K60 & SD-0104-4K60 are high performance 18Gbps 1x2/4 HDMI2.0 Splitters, it can support 1 HDMI input to 2/4 HDMI outputs simultaneously.

The resolution is up to 4K60Hz. It supports EDID management, auto scaling function to fix different display resolutions, also with one 3.5mm audio de-embedded function.

The ON/OFF power switch provides conveniences for users to turn it ON/OFF without the power cable plugging and unplugging.



SD-0102-4K60



SD-0104-4K60



Key Features

- HDCP2.2 compliant
- Support video bandwidth 18 Gbps
- Video resolution is up to 4K2K@50/60Hz
- Support 3D, HDR, Dolby Vision function
- EDID management by the DIP switch settings
- Output resolution auto scaling
- Supports 3.5mm audio de-embedded
- No need to install the driver, plug and play.

SPECIFICATIONS

HDCP COMPLIANCE	HDCP2.2
VIDEO BANDWIDTH	18GBPS
RESOLUTION	4K2K50/60HZ 4:4:4, 4K2K 30HZ 4:4:4, 1080P, 1080I, 720P, 720I, 480P, 480I, HDMI 3D TV FORMATS ALL PC RESOLUTIONS INCLUDING 1920X1200
3D SUPPORT	YES
COLOUR SPACE	RGB, YCBCR 4:4:4, YCBCR 4:2:2, YCBCR 4:2:0
COLOUR DEPTH	8/10/12-BIT
HDMI AUDIO FORMATS	PCM2.0/5.1/7.1CH, DOLBY DIGITAL/PLUS/EX, DOLBY TRUE HD, DTS, DTS-EX, DTS-94/24, DTS HIGH RES, DTS-HD MASTER AUDIO, DSD
HDR FORMATS	HDR10, HDR10+, DOLBY VISION
INPUT PORTS	1x HDMI TYPE A (19-PIN FEMALE)
OUTPUT PORTS	2/4x HDMI TYPE A (19-PIN FEMALE), 1X 3.5MM AUDIO
DIMENSIONS (MM)	140x61x27 (SD-0102-4K60) 208x61x27 (SD-0104-4K60)
POWER SUPPLY	12V/1.5 A DC OUTPUT: DC 5V/1A
POWER CONSUMPTIONS	UP TO 2.5W (SD-0102-4K60) UP TO 3.5W (SD-0104-4K60)

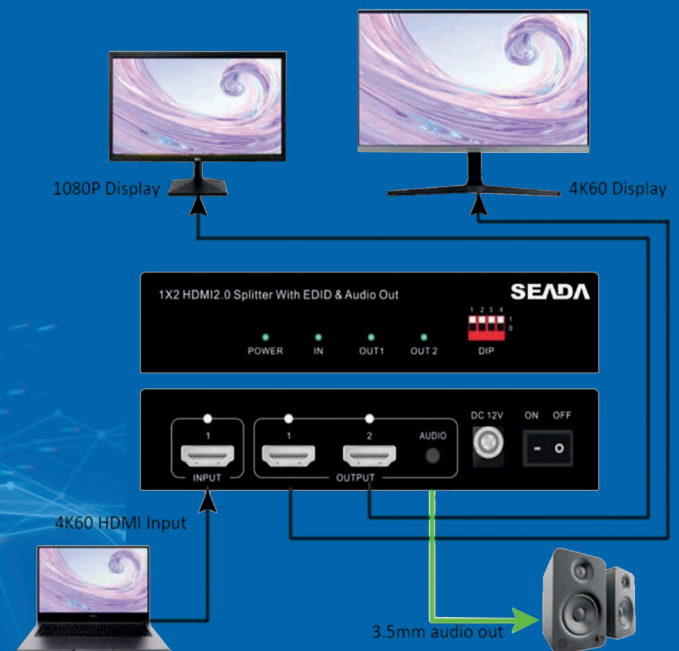

**here only takes 1x2 as an example*



KVM50HD HDMI/USB



Key Features

- HDMI 1.4b, HDCP 1.4 and DVI compliant
- Video resolutions up to 1080p@60Hz
- HDMI audio pass through
- Zero latency and uncompressed transmission technology

DESCRIPTION

The HDMI/USB KVM Extender can extend high-definition HDMI and USB signals up to 164ft/50m over a single Cat5e/6 cable with zero latency. It supports HDMI 1.4b and USB 2.0 standards.

Two-way POC (Power over Cable) function allows either TX or RX to be powered by a single 12V@1A power supply. It's an ideal product for cyber bar and KVM extender markets.

- USB2.0 Full-speed transmission and routing
- 12VPOC (Power over Cable) function supported

SPECIFICATIONS

	KVM50HD
VIDEO RESOLUTIONS	UP TO 1920 x 1080 60Hz
BANDWIDTH	175MHz[5.4GBPS]
RECEIVER	
INPUTS	1x RJ45
OUTPUTS	1x HDMI, 2x USB-A
PSU	DC 12V 1A
DIMENSIONS (IN MM)	109[W] x 76.5[D] x 25.4[H]
TRANSMITTER	
INPUTS	1x HDMI, 1x USB-B
OUTPUTS	1x HDMI, 1x RJ45
PSU	DC 12V 1A
DIMENSIONS (IN MM)	109[W] x 76.5[D] x 25.4[H]

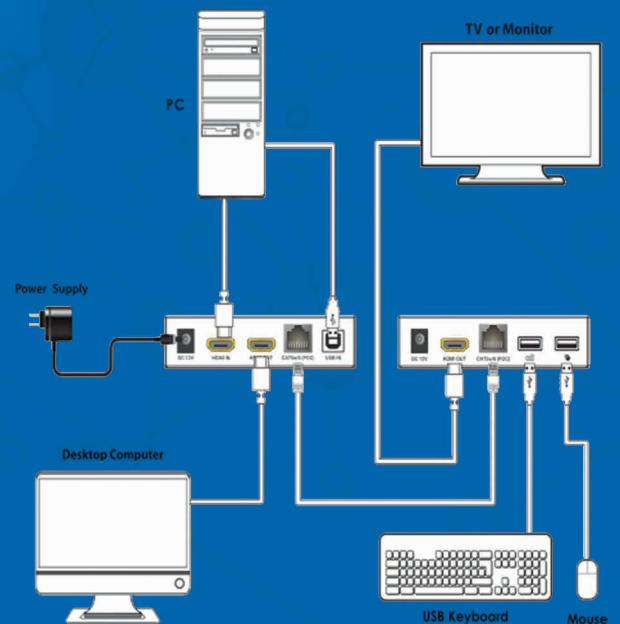

DESCRIPTION

The HDMI USB KVM (Keyboard, Video, Mouse) Extender is a tool which can extend your HDMI signal over 328fts/100meters to a compatible display. It is designed to convert HDMI signal to standard HDBaseT signal which can be transmitted by CAT5e/CAT6/CAT7 cable.

It also supports the connection of USB host and 2 USB device ports. Allows you to control the Source in the Sink side, which is 328fts outside, also you can control the Sink in the Source side which is 328fts outside using the HDMI Extender.



HBT100UB



Key Features

- Fully compliant with HDMI 1.4, and compatible with HDMI 2.0 (4K2K@60Hz with YCbCr4:2:0)
- Supports HDBaseT 2.0 specification over a single CAT5e/6/7 cable up to 100m/328ft.
- Supports pass-through of HD audio formats: LPCM2/5.1/7.1 CH, Dolby Digital, DTS, Dolby TrueHD, DTS-HD (Master Audio)
- POE (Power Over Ethernet) function supported
- Full HD support: 1080p@60Hz@24/36/48bit/pixels.
- Supports USB 2.0 control.
- Supports external Bi-Directional SPDIF IN/OUT and available for multichannel audio.
- Transfers bi-directional Ethernet, RS232 and Infrared control signal together with the HDMI signal

SPECIFICATIONS

	HBT100UB
VIDEO RESOLUTIONS	UP TO 1920 X 1080 60Hz
BANDWIDTH	340MHz[10.2GBPS]
RECEIVER	
INPUTS	1X IR, 1X SPDIF, 1X RJ45 (HDBASET), 1X USB-H
OUTPUTS	1X HDMI, 1X RJ45 (Ethernet), 2X USB, 1X IR, 1X3.5mm JACK, 1X PHOENIX, 1X SPDIF
PSU	DC 24V 1A
DIMENSIONS (IN MM)	160[W] X 97[D] X 28[H]
TRANSMITTER	
INPUTS	1X HDMI, 1X RJ45 (ETHERNET), 1X USB-H, 1X IR, 1X SPDIF, 1X3.5mm JACK, 1X PHOENIX
OUTPUTS	1X IR, 1X SPDIF, 1X RJ45 (HDBASET), 2x USB-D
PSU	DC 24V 1A
DIMENSIONS (IN MM)	160[W] X 97[D] X 28[H]

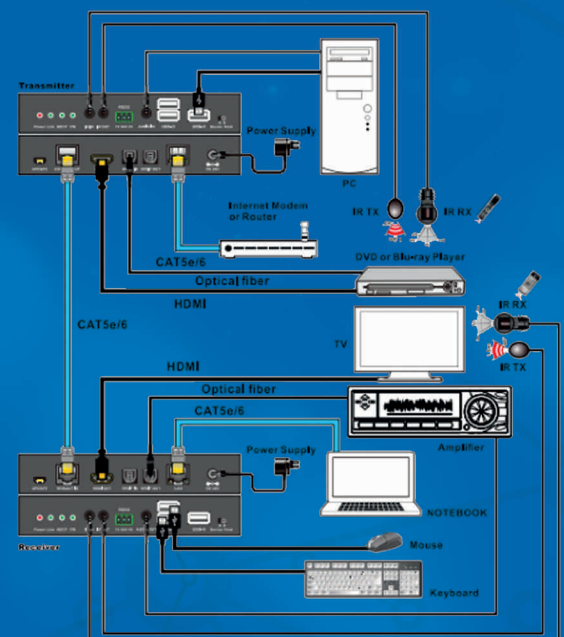

HDMI & SDI Converters



SD-STH



SD-HTS

DESCRIPTION

SD-STH & HTS features input/output for SDI and output/input for HDMI, allowing seamless conversion of the video signal from one format to another.

These converters play a vital role in ensuring compatibility and seamless connectivity across different video equipment and systems.



SD-HTS

Key Features

- Convert HDMI to SD/HD/3G-SDI
- Distributes 1 HDMI source to 2 SD/HD/3G-SDI output simultaneously
- Support HDMI input resolutions: 1080p (50/60/59.94/30/29.97/25/24/23.98Hz) 1080i (60/59.94/50Hz), 720p (60/59.94/50Hz), 480i (60/59.94Hz)
- Work with SDI to HDMI converter to cascade many layers
- Support transmission distance up to 100m over RG59 cable
- With mounting ears

SPECIFICATIONS

MODEL NAME	SD-HTS	SD-STH
SDI STANDARD	3G-SDI/HD-SDI/SDI	3G-SDI/HD-SDI/SDI
INPUT	1x HDMI (STANDARD TYPE A CONNECTOR)	1x SDI (BNC)
OUTPUT	2x SDI (BNC)	1x SDI (BNC), 1x HDMI (TYPE A CONNECTOR)
OUTPUT IMPEDANCE	-	75OHMS
OPERATING TEMPERATURE	-5 TO 35°C (+23 TO +95°F)	-5 TO 35°C (+23 TO +95°F)
OPERATING HUMIDITY	5 TO 90%RH (NO CONDENSATION)	5 TO 90%RH (NO CONDENSATION)
RESOLUTIONS FORMATS	1080P @23.98/24/25/29.97/30/50/59.94/60HZ 1080i @50/59.94/60HZ 480i @59.94/60HZ	1080P @23.98/24/25/29.97/30/50/59.94/60HZ 1080i @50/59.94/60HZ 720P@50/59/94/60HZ 576i @50HZ 480i @59.94/60HZ
POWER CONSUMPTION	2.5WATTS (MAXIMUM)	2.5WATTS (MAXIMUM)
WEIGHT	245G	245G
DIMENSION (L x W x H)	95x95x29MM	95x95x29MM

SD-STH

Key Features

- Convert SD/HD/3G-SDI to HDMI
- Distribute 1 SD/HD/3G-SDI to 1 HDMI plus 1 looping SDI output simultaneously
- Support SDI input resolutions: 1080p (50/60/59.94/30/29.97/24/23.98Hz) 1080i (60/59.94Hz), 720p (60/59.94/50Hz), 576i (50Hz), 480i (60/59.94Hz)
- Work with HDMI to SDI converter to cascade many layers
- Support transmission distance up to 100m over RG59 cable
- With mounting ears

Video Capture and Record

DESCRIPTION

SEADA's SD-HU and SD-UHU are USB3.0 Video Capture Devices that are compact and easy to carry around, with superior performance and compatibility, easy set up, and many other features.

The capture video resolution is up to 1080p60Hz. It supports many USB3.0 chipsets (Intel, Renesas, ASMedia, Fresco Logic etc.) and is compatible with PCIe Gen 1.1 x1 expansion via USB 3.0.

The product meets UVC and UAC standard. Simple plug and play, no driver and setting installation required.

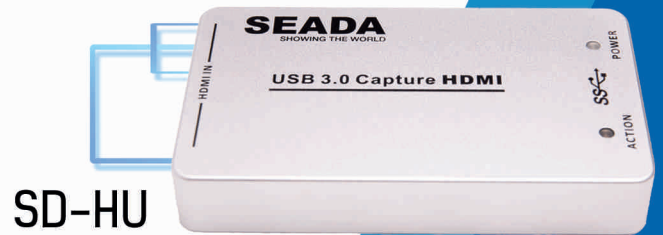

SD-HU



SD-UHU



Key Features

SD-HU

- It is compatible with Windows, Linux, and OS X operating systems
- USB3.0, 300~350MB/s throughput and it is compatible with USB 2.0
- The capture of video and audio is all done by SD-HU and will not slow down the CPU
- It can capture one single channel HD HDMI video signal
- It can automatically detect the input video formats and adjust output size and frame rate automatically
- The input and output video signals can reach 1080p/60 Hz
- It is compatible with UVC video capture and supports YUV 422 video output

SD-UHU

- Supports HDMI video input capture and HDMI loop output
- Supports resolution 480i~1080p60Hz format video capture
- Supports resolution 4K2K@60Hz (Down Scaler)->1080p60Hz video capture (Attention: 4K2K@50/60Hz 4:2:2 resolution not supported down scaler function.)
- HDMI input and HDMI loop output supports HDMI 2.0, HDCP 2.2, resolution the maximum up to 4K2K@60Hz (4:4:4)
- Supports analog stereo audio input. (Double audio inputs selected to capture audio)
- Supports analog stereo audio output de-embedded from HDMI source
- Supports USB3.0 with transmission rate up to 300~350MB/s

SPECIFICATIONS

USB 3.0 CAPTURE HDMI	SD-HU	SD-UHU
DIMENSION (W x H x D)	98x56x16	98x60x17
INPUT INTERFACE	HDMI TYPE A	1xHDMI IN [19-PIN FEMALE] 1xAUDIO IN [3.5mm STEREO MINI JACK]
HDMI INPUT RESOLUTIONS	UP TO 1080p@60	UP TO 4k2k@60[4:4:4]
OUTPUT RESOLUTIONS	UP TO 1920x1080	UP TO 1920x1080
OUTPUT FRAME RATE	25/29 97/30/50/59 94/60 FPS	25/29 97/30/50/59 94/60 FPS
AUDIO AND VIDEO CAPTURE	STANDARDS OF UVC AND UAC	STANDARDS OF UVC AND UAC
OS SUPPORTED	WINDOWS 7/8/10, LINUX (KERNEL VERSION 2.6.38 AND ABOVE), OS X (10.8 AND ABOVE)	WINDOWS 7/8/10, LINUX (KERNEL VERSION 2.6.38 AND ABOVE), OS X (10.8 AND ABOVE)
OPERATING TEMPERATURE RANGE	0~40 DEGREES CENTIGRADE	0~40 DEGREES CENTIGRADE
OPERATING HUMIDITY RANGE	10%-90% NON-CONDENSING	10%-90% NON-CONDENSING
MAX POWER CONSUMPTION	2.5W	3.4W

Video Wall Screens



DESCRIPTION

With a total screen-to-screen bezel size of 3.5mm, these displays are ideal as part of a virtually seamless LCD video wall – providing you with an eye catching, and content focused display. Their super narrow bezel allows you to build video walls of any size.

These displays feature a HDMI in and out so that you can daisy chain video walls of any size without the need for an expensive external matrix controller; providing a hassle free, cost-effective solution.

Commercial grade IPS technology accurately displays image quality and colour depth with no fall-off in colour accuracy. These panels are designed to achieve ultimate life like colour temperature when used in either landscape or portrait.



Key Features

- 49/55 inch LCD video wall displays
- Super narrow bezel (3.5mm)
- Daisy chain tiling
- 500cd/m² IPS panel
- 4K compatible video walls
- Low power consumption
- Multiple inputs
- Power timer
- Smart temperature control
- Wide viewing angle

SPECIFICATIONS

MODEL	SD49LBH7-49"	SD55LBH7-55"
RESOLUTION	1920 x 1080	1920 x 1080
BEZEL SIZE (IN MM)	BOTTOM/RIGHT:2.34, TOP/LEFT:1.16	BOTTOM/RIGHT:1.2, TOP/LEFT:2.3
DISPLAY AREA (IN MM)	1074 x 604.3	1209.9 x 680.7
ASPECT RATIO	16:9	16:9
COLOURS	16.7M	16.7M
COLOUR TEMPERATURE	10000K	10000K
VIEWING ANGLE	178°	178°
CONTRAST RATIO	4000:1	4000:1
INPUTS	HDMI, VGA, DVI, RS232, DP, USB	HDMI, VGA, DVI, RS232, DP, USB
OUTPUTS	RS232 x2, HDMI, AUDIO	RS232 x2, HDMI, AUDIO
POWER CONSUMPTION	155W	160W
INPUT VOLTAGE	100V-240V (50/60 HZ)	100V-240V (50/60 HZ)
UNIT SIZE (IN MM)	1077.5(W) x 607.8(H) x 291(D)	1213.4(W) x 684.2(H) x 117.9(D)
PACKAGE SIZE (IN MM)	1267.5(W) x 877(H) x 291(D)	1400(W) x 950(H) x 280(D)
VESA HOLES (IN MM)	600 x 300	600 x 300
NET WEIGHT (KG)	25	31.5
GROSS WEIGHT (KG)	33.3	40.6

4K Premium HDMI Cables

DESCRIPTION

These SCHM Series Premium 4K HDMI Cables from SEADA, can ensure the robust performance even with 4K@60 signal with its 26 AWG wiring.

The SCHM series cables range in lengths from 1m to 10m making it perfect for any set up.

Key Features

- 26AWG cable wiring
- Support 18Gbps Bandwidth
- Superior transfer rates, up to 18Gb/s @60Hz ideal for 4K
- Support all HDMI embedded audio formats

MODELS

PART NUMBER	DESCRIPTION
SCHM01	1M 4K HDMI2.0 HDMI COPPER CABLE WITH 26 AWG CONDUCTOR GAUGE
SCHM02	2M 4K HDMI2.0 HDMI COPPER CABLE WITH 26 AWG CONDUCTOR GAUGE
SCHM03	3M 4K HDMI2.0 HDMI COPPER CABLE WITH 26 AWG CONDUCTOR GAUGE
SCHM05	5M 4K HDMI2.0 HDMI COPPER CABLE WITH 26 AWG CONDUCTOR GAUGE
SCHM10	10M 4K HDMI2.0 HDMI COPPER CABLE WITH 26 AWG CONDUCTOR GAUGE

SPECIFICATIONS

HDMI CONNECTOR	TYPE A
TOTAL BANDWIDTH	18GBPS
OPERATING TEMPERATURE RANGE	0~50 DEGREES CENTIGRADE
OPERATING HUMIDITY RANGE	10%~90% NON-CONDENSING
STORAGE TEMPERATURE RANGE	-20~70 DEGREES CENTIGRADE
STORAGE HUMIDITY RANGE	10%~90% NON-CONDENSING



Active Optical Cables



Overview

- HDMI, USB 3.0, Type C, DP to HDMI, USB F to M
- Low power consumption, no external power supply needed
- Thinner, lighter, and softer than the normal copper cable
- Lengths ranging from 10m to 100m
- Plug & Play no driver required
- RF screening to prevent interference

DESCRIPTION

These SC-4K60 Series HDMI Active Optical Cables (AOC) from SEADA can carry HDMI HDR signal up to 4K@60fps 4:4:4 at 18Gbps data rate up to 100 meters without any compression. Comprised of a fiber and traditional copper wire cable, this active cable is less susceptible to EMI interference, for a clear and reliable audio/video signal.

SPECIFICATIONS

Model	Description	Length
SC-4K60	4K60 HDMI 2.0 ACTIVE OPTICAL CABLE WITH 18G BANDWIDTH	10M, 15M, 20M, 25M, 30M, 40M, 50M, 60M, 70M, 80M, 90M, 100M

SC-4K60 Series



DESCRIPTION

The SC-AVC Series Active Optical Cable (AOC) is the perfect solution to transfer large and high-quality video and audio over long lengths (up to 30m) without nearly any loss from type c port to another type c port.

SPECIFICATIONS

Model	Description	Length
SC-AVC	TYPE C TO TYPE C AOC, 4K@60Hz, 21.6 Gbps, AUDIO/VIDEO	10M, 15M, 20M, 25M, 30M

SC-AVC Series



DESCRIPTION

These SC-DPH Series Active Optical Cables (AOC) from SEADA can take a Display video input and convert it to HDMI signal and then transmit this HDMI signal up to 4K@60fps 4:4:4 at 18Gbps data rate up to 60 meters without any compression. Comprised of a fiber and traditional copper wire cable for a clear and reliable audio/video signal.

SPECIFICATIONS

Model	Description	Length
SC-DPH	DP TO HDMI AOC, 4K@60Hz 4:4:4, SUPPORT HDCP2.2/HDR/ARC	10M, 15M, 20M, 25M, 30M, 40M, 50M



SC-DPH Series

DESCRIPTION

The SC-UMM Series USB 3.0 Active Optical Cable (AOC) is a USB 3.0 electrical to optical conversion module. This product can translate signals between USB 3.0 electrical and optical signals. AOC is a cabling technology that accepts the same electrical inputs as a traditional copper cable but uses optical fiber "between the connectors".

SPECIFICATIONS

Model	Description	Length
SC-UMM	USB3.0 AOC, MALE TO MALE, 5Gbps, USB2.0 NOT SUPPORTED	10M, 15M, 20M, 25M, 30M, 40M, 50M



SC-UMM Series

DESCRIPTION

The SC-UFM Series USB 3.0 Active Optical Cable (AOC) is a USB 3.0 electrical to optical conversion module. This product can translate signals between USB 3.0 electrical and optical signals. AOC is a cabling technology that accepts the same electrical inputs as a traditional copper cable but uses optical fiber "between the connectors".

SPECIFICATIONS

Model	Description	Length
SC-UFM	USB3.0 AOC, FEMALE TO MALE, 5Gbps, COMPATIBLE WITH USB2.0	10M, 15M, 20M, 25M, 30M, 40M, 50M



SC-UFM Series



SEADA

Showing the World

SEADA TECHNOLOGY LTD

SEADA House, Saxon Business Park,
Hanbury Road, Bromsgrove,
Worcestershire, B60 4AD,
United Kingdom



+44 (0) 1527 584364



sales@seada.co.uk



[@SeadaTechnology](https://twitter.com/SeadaTechnology)



[seada-technology-ltd](https://www.linkedin.com/company/seada-technology-ltd)



www.seada.co.uk

