

DataLok SR boot and secure lock for Category 6 and Category 6A patch leads

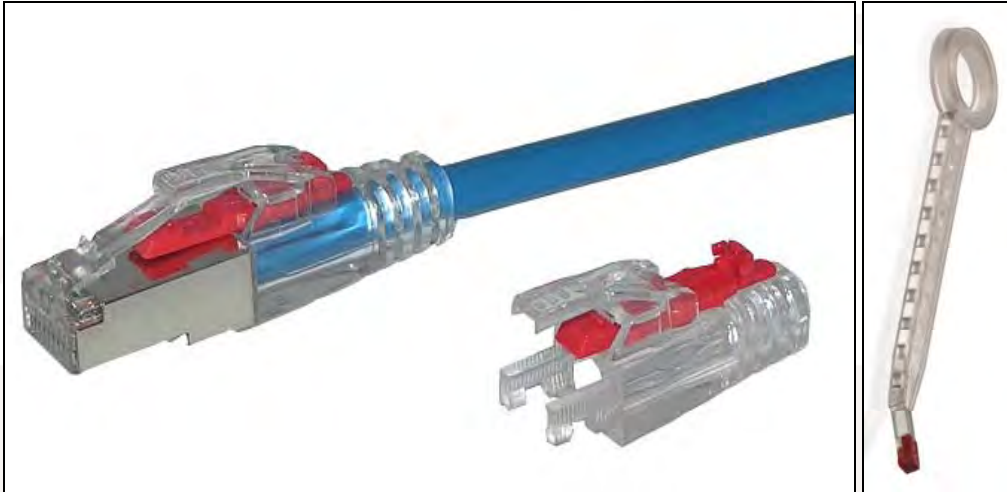

DataLok SR boot (PSDL5 or PSDL6), Secure lock (PSDSL) and Tool (TPS)

Strain relief based locking components for Category 5e, Category 6 and Category 6A patch cords

Features

- Compatible with TUK and most industry standard RJ45 Category 5e, Category 6 and Category 6A plugs
- Patented design, high quality polycarbonate used throughout
- Slim-line and compact design flush snag-less strain relief boots, suitable for patching into high density hubs
- Tamper Resistant – Secure lock locks in the plug for added physical security
- Enhanced Security - Removal tool (code: TPS) required to release to secure lock
- Extended hood prevents latch snagging
- Suitable for cable OD 5.8 - 6.8mm
- Easy to assemble, no special tools required
- Different sized legs for Category 5e or Category 6/6A plugs (PSDL5 – 3.4mm or PSDL6 – 4.3mm)

Specifications

Materials:

- Boot, Secure lock and Tool: high quality crystal polycarbonate

Colours:

- Boot and Tool: transparent, Secure lock: red

ROHS Compliant

Code: PSDL5

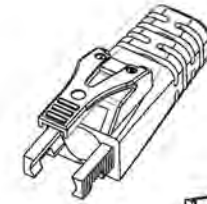
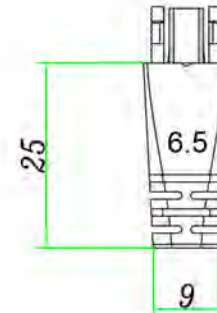
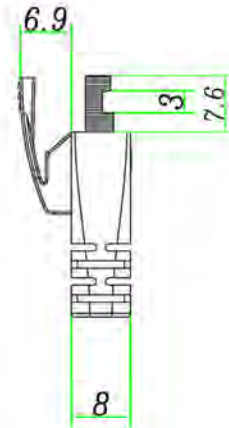
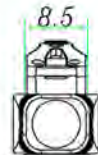
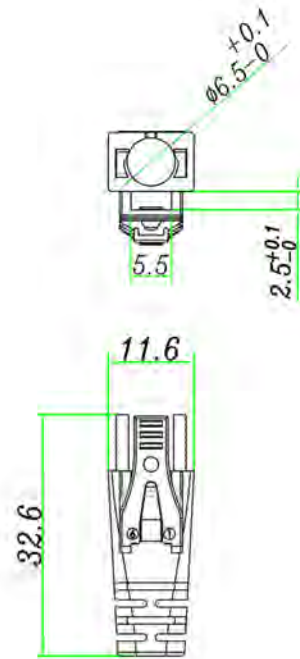
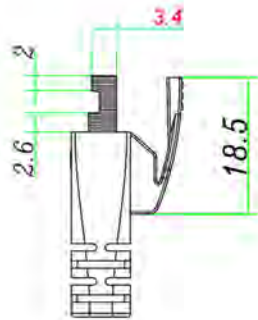

Locking boot for Category 5e, 6.5" OD
Clear white
Material: PC UL 94V-0
Packing: 100pcs/bag

UNLESS OTHERWISE SPECIFIED TOLERANCE	
ANG.	± 5°
0.	± 0.20
.0	± 0.15
.00	± 0.10

ROHS Compliant

Code: PSDL6

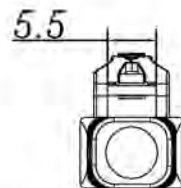
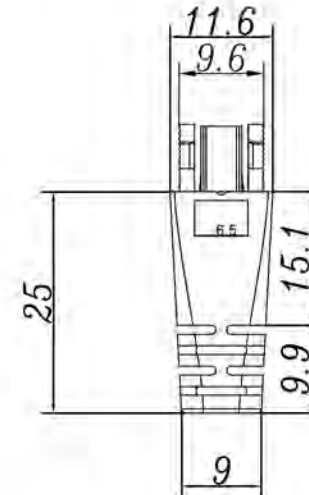
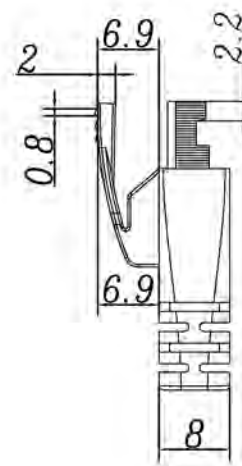
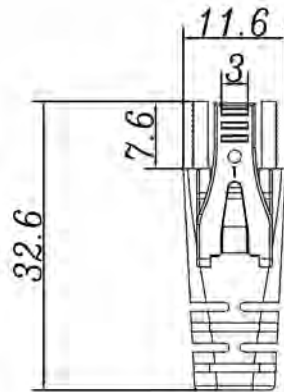
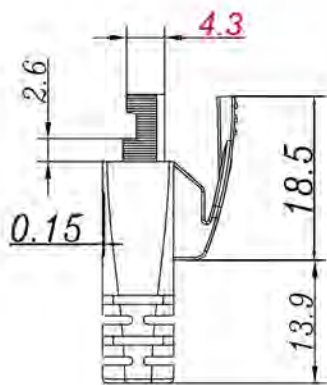
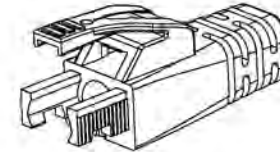
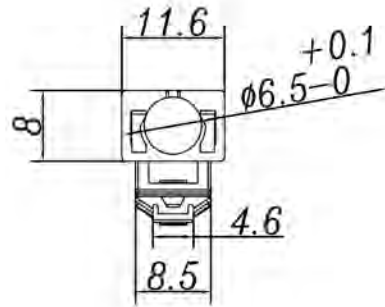

Material: PC UL 94V-0 Clear White
Packing: 100pcs/bag

ROHS Compliant

**Code: PSDSL
TPS**

