

SPEEDY RJ45 Plugs



Plug for Category 5e and plug for Category 6

Our **SPEEDY** RJ45 plugs are designed to simplify twisted pair terminations by allowing the wire pairs to be easily inserted through the plug and out of the front. This allows the installer to easily check the wiring order before crimping the connector. Twist is maintained more easily enabling a better performing crimp. Waste is minimised and the plugs are suitable for either stranded or solid wires.

Features

- Each plug allows twisted pair wires to be inserted through the body and pulled out of the front to ensure the correct wiring order before crimping
- By pulling the cores into the plug, twists can easily be maintained up to the contacts, enabling fully rated category performance
- Contact blades are suitable for stranded or solid wire cores from 24-26 AWG (0.51 – 0.40mm), with insulation up to 1.0mm O.D.
- Plugs available for both Category 5e and 6 twisted pair terminations
- Perfect solution for rapid termination
- Suitable for termination of solid or stranded UTP cables with sheath O.D. of 5.0 – 6.0mm
- Faults and failures minimised
- Simple one piece design
- Less cable scrap and wastage
- **N.B. Must be used with suitable crimp tool (e.g., our code TRCSPDY or TRCSPDY3)**

Specifications

- Housing material: Polycarbonate UL94V-0
- Gold plating: 1.27µm/50µ"
- 3 prong contact for solid or stranded cores
- Housing colour: transparent
- Operating temperature: -10°C to 60°C

Packaging

Supplied in polybags of 10 then 100 then 500. Also available with reduced packaging as bags of 200

- 10:** PXSPDY5#10 (Category 5e)
PXSPDY6#10 (Category 6)
- 100:** PXSPDY5#100 (Category 5e)
PXSPDY6#100 (Category 6)
- 200:** PXSPDY5#200 (Category 5e) (Supplied loose in bag)
PXSPDY6#200 (Category 6) (Supplied loose in bag)
- 500:** PXSPDY5#500 (Category 5e)
PXSPDY6#500 (Category 6)

Commodity code: 85444920

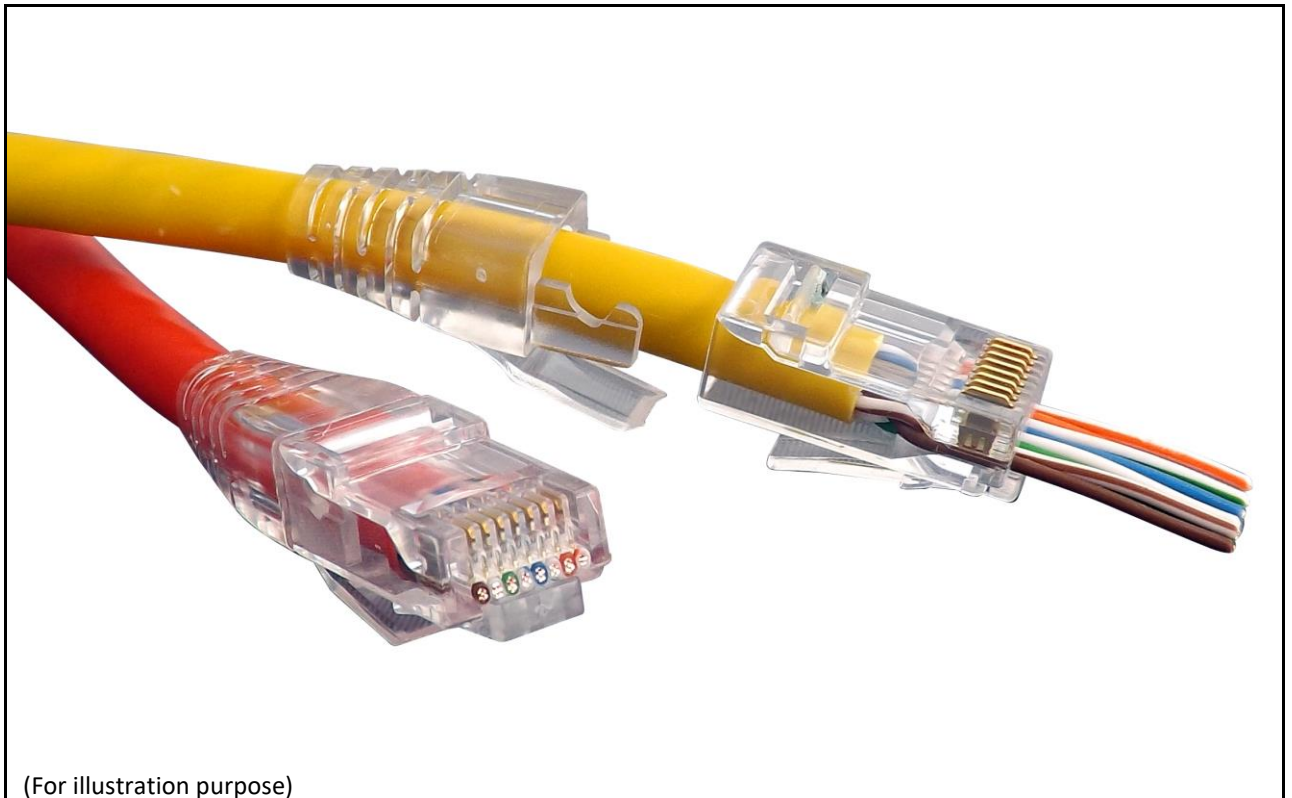

Note: Not permitted for sale in the USA

ROHS Compliant

Code: PXSPDY5

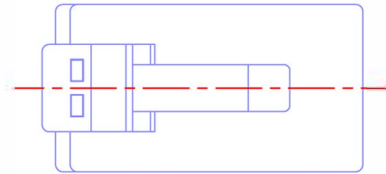

1. Housing material: Polycarbonate
Flammability rating: UL 94V-0, RoHS Compliant
2. Contacts type: Three prong pin fits solid or stranded wires from 0.51 - 0.40mm (24 - 26 AWG)
3. Gold plating: 50 μ "/1.27 μ m
4. Packaging quantity: #500 = 500 pcs
#200 = 200 pcs
#100 = 100 pcs
#10 = 10 pcs
5. Housing colour: Transparent
6. Operating temperature: -10°C to 60°C
7. Suitable for cable O.D. 5.0 - 6.0mm

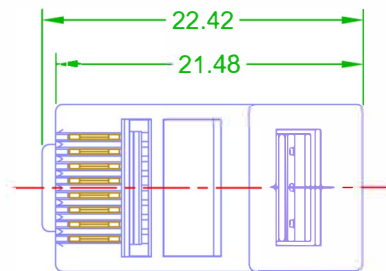
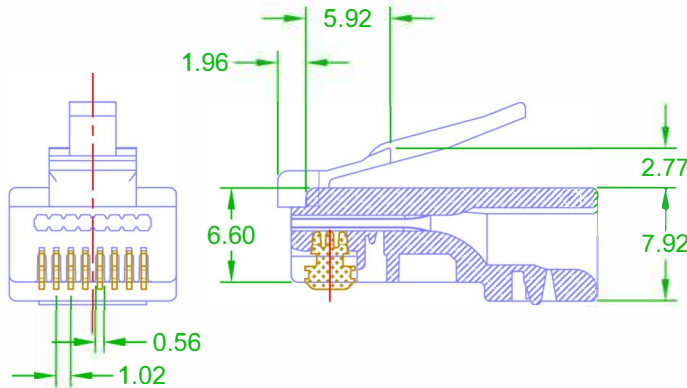
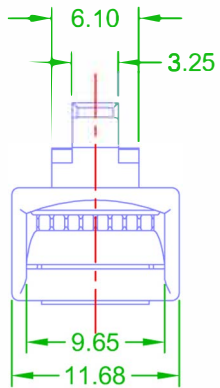

Three prong pin
(not to scale)



ROHS Compliant

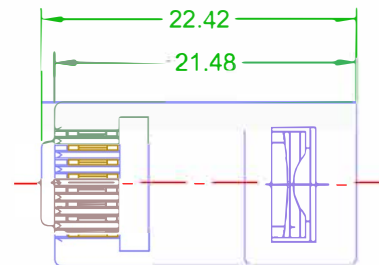
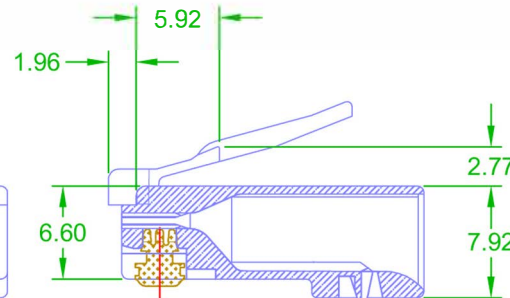
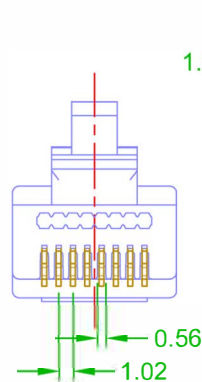
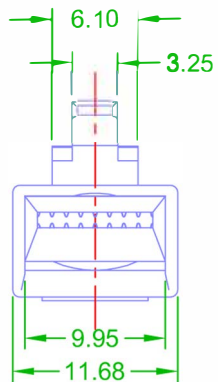
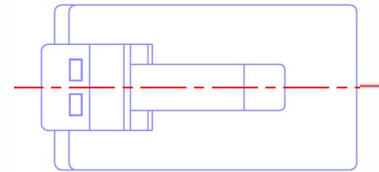

1. Housing material: Polycarbonate
Flammability rating: UL 94V-0, RoHS Compliant
2. Contacts type: Three prong pin fits solid or stranded wires from 0.51 - 0.40mm (24 - 26 AWG)
3. Gold plating: 50 μ "/1.27 μ m
4. Packaging quantity: #500 = 500 pcs
#200 = 200 pcs
#100 = 100 pcs
#10 = 10 pcs
5. Housing colour: Transparent
6. Operating temperature: -10°C to 60°C
7. Suitable for cable O.D. 5.0 - 6.0mm



Three prong pin
(not to scale)